



MIGA

**Multilateral Investment
Guarantee Agency**
WORLD BANK GROUP

Political Risk Insurance Solutions

- 1. MIGA in the World Bank Group**
2. MIGA's Political Risk Insurance
3. MIGA Guarantee Examples
4. MIGA's Value Added
5. MIGA's Performance

Appendix

- MIGA Underwriting Process
- Other Project Examples
- Award-Winning Projects

World Bank Group

	IBRD International Bank for Reconstruction and Development	IDA International Development Association	IFC International Finance Corporation	MIGA Multilateral Investment Guarantee Agency
	Est. 1945	Est. 1960	Est. 1956	Est. 1988
Role:	Support countries' economic and institutional development	Support countries' economic and institutional development	Promote private sector development	Promote cross-border investment and lending
Clients:	Governments of member countries with annual per capita income between \$1,025 and \$6,055	Governments of member countries with annual per capita income of less than \$1,025	Investors in member countries	Debt and Equity investors in member countries
Products:	<ul style="list-style-type: none"> - Technical Assistance - Loans - Policy Advice 	<ul style="list-style-type: none"> - Technical Assistance - Interest-Free Loans - Policy Advice 	<ul style="list-style-type: none"> - Equity/Quasi-Equity - Long-Term Loans - Advisory Services 	<ul style="list-style-type: none"> - Political Risk Insurance - Credit Enhancement

←..... **Shared Mission: “End extreme poverty and build shared prosperity”**→

1. MIGA in the World Bank Group
- 2. MIGA's Political Risk Insurance**
3. MIGA Guarantee Examples
4. MIGA's Value Added
5. MIGA's Performance

Appendix

- MIGA Underwriting Process
- Other Project Examples
- Award-Winning Projects

Risks Faced by Investors and Lenders: Political Risk Insurance Solutions

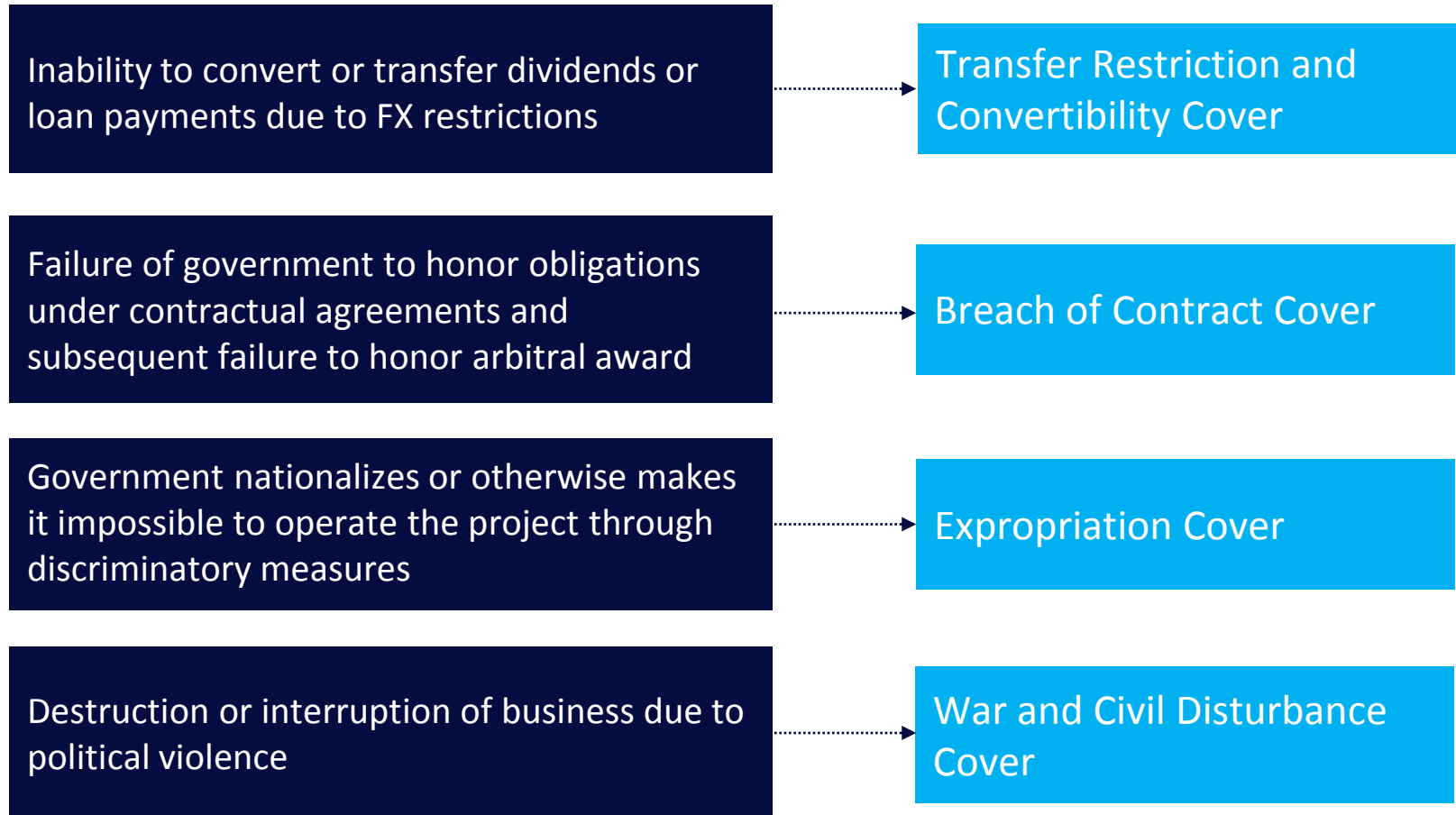

Foreign Direct Investment to sub investment grade countries (BB and below)

In US\$ billion and years

FDI Inflows, USD bn

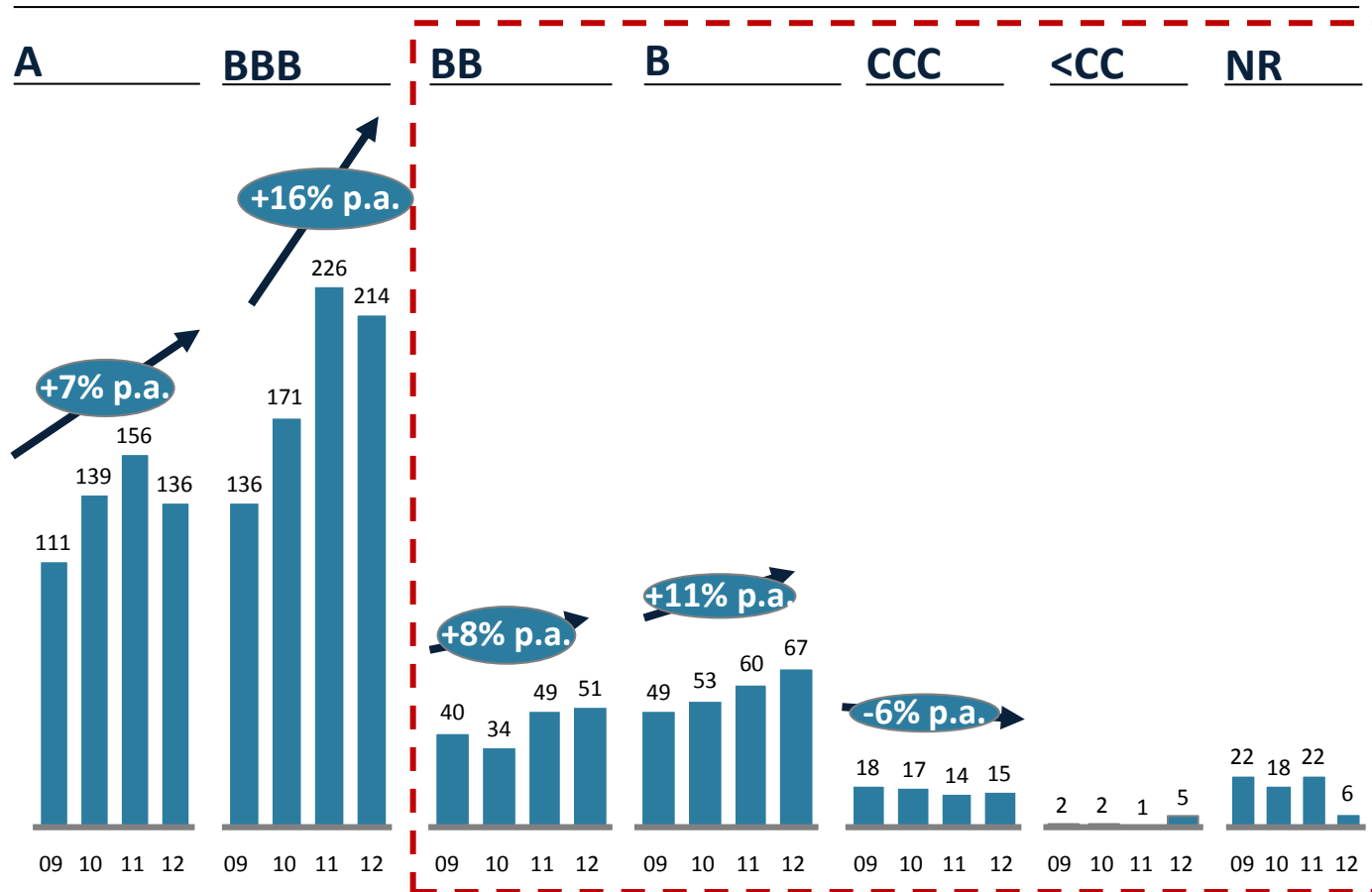

BB/B/CCC/<
CC and NR

Growth
rate:
3.2%

1. MIGA in the World Bank Group
2. MIGA's Political Risk Insurance
- 3. MIGA Guarantee Examples**
4. MIGA's Value Added
5. MIGA's Performance

Appendix

- MIGA Underwriting Process
- Other Project Examples
- Award-Winning Projects

Political Risk Insurance – Breach of Contract Cover

Azito Energie S.A., Côte d'Ivoire

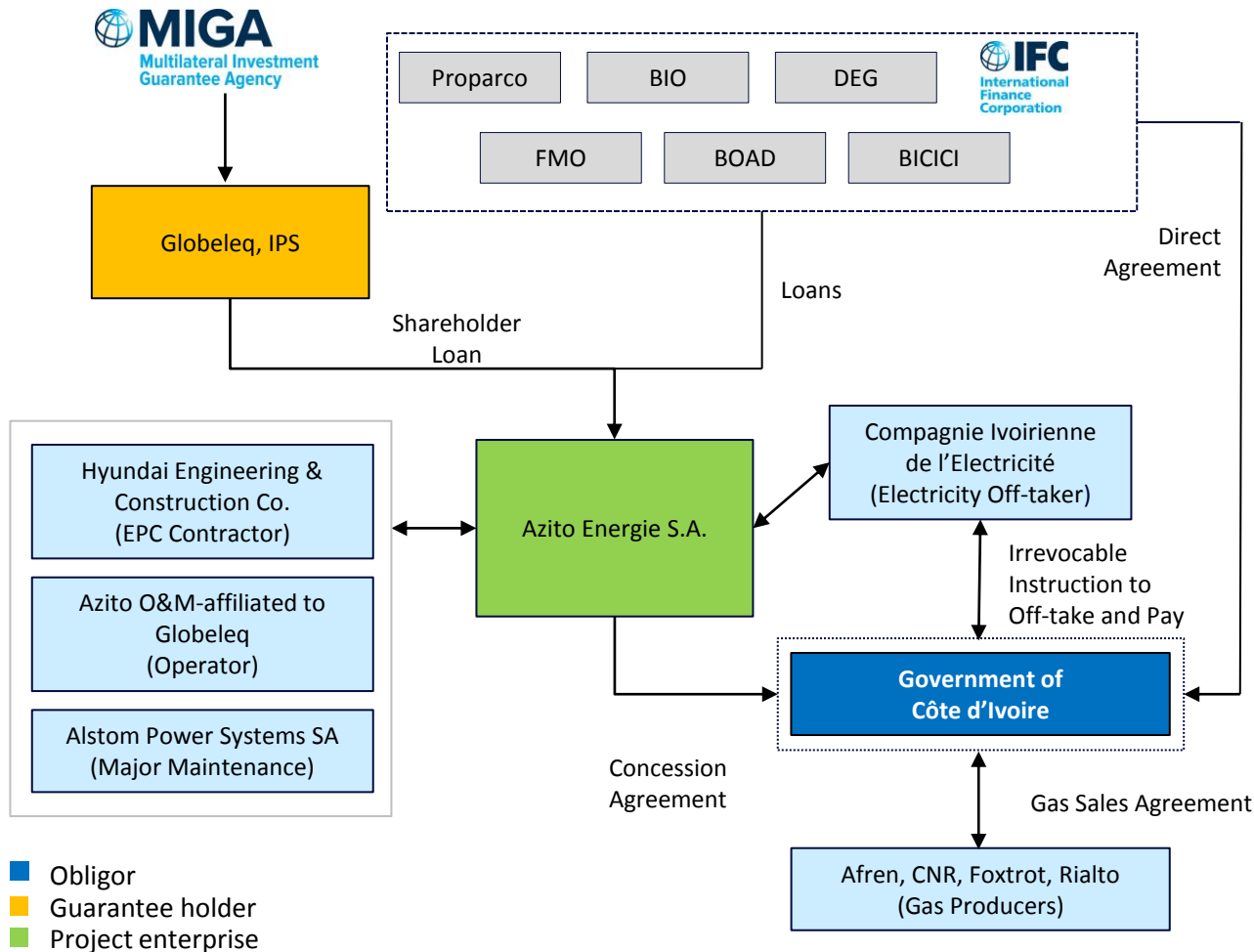

- ❖ **Project:** Conversion of the existing Thermal Power Plant from simple-cycle to combined-cycle
- ❖ 20-year power purchase agreement with CIE
- ❖ MIGA cover
 - Amount: \$116.1m
 - Tenor: 20 years
 - Issued: December 2012

Political Risk Insurance – Expropriation, Transfer and Convertibility, War and Civil Disturbance, and Breach of Contract

Rajamandala Hydropower Project, Indonesia

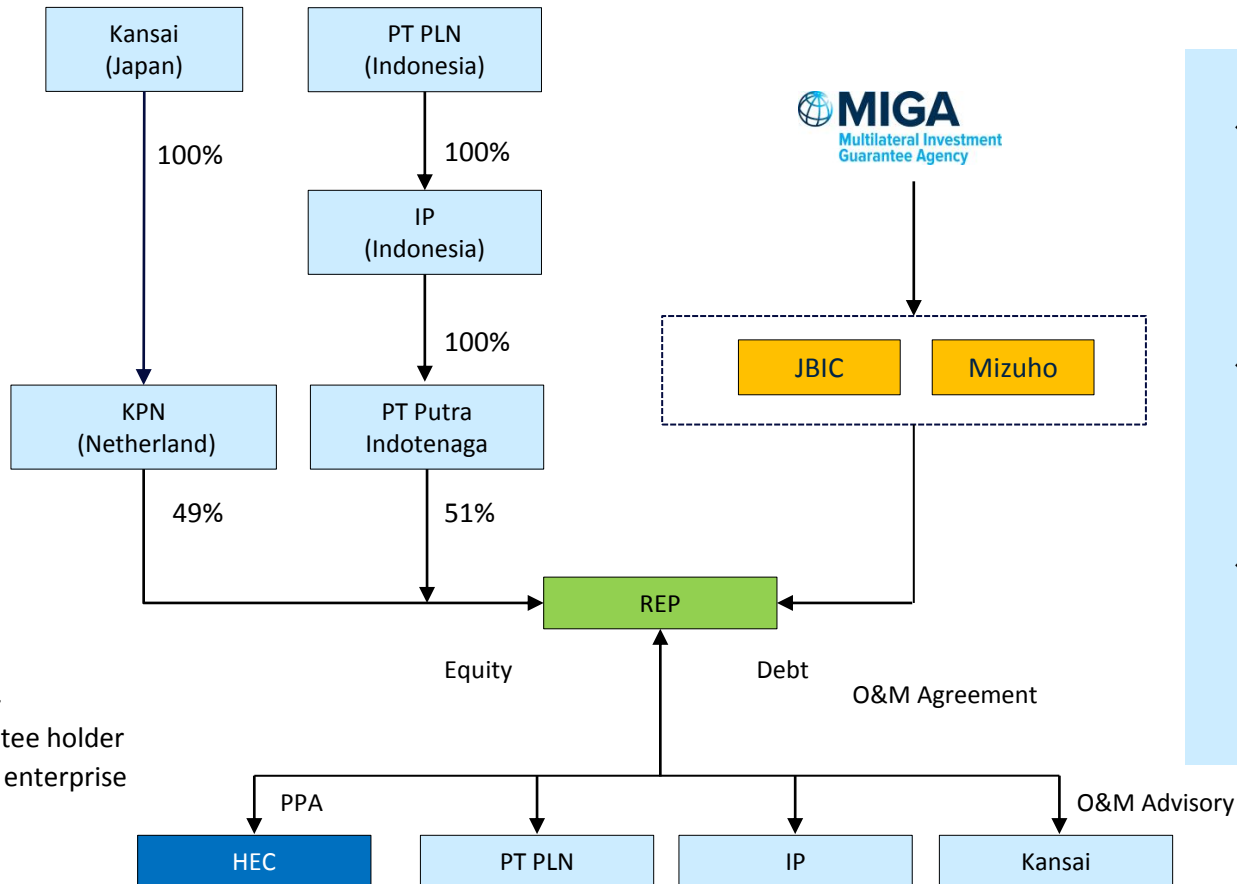

- ❖ **Project:** Development and operation of a 47 megawatt run-of-the-river hydropower plant near Bandung on Java Island on a build-operate-transfer basis
- ❖ 30-year power purchase agreement with PT Perusahaan Listrik Negara (PLN), a state-owned enterprise.
- ❖ MIGA cover
 - Amount \$200m
 - Tenor: 19 years
 - Issued: August 2014

Political Risk Insurance – Expropriation, Transfer and Convertibility, Breach of Contract Cover

Adana Integrated Health Campus, Turkey

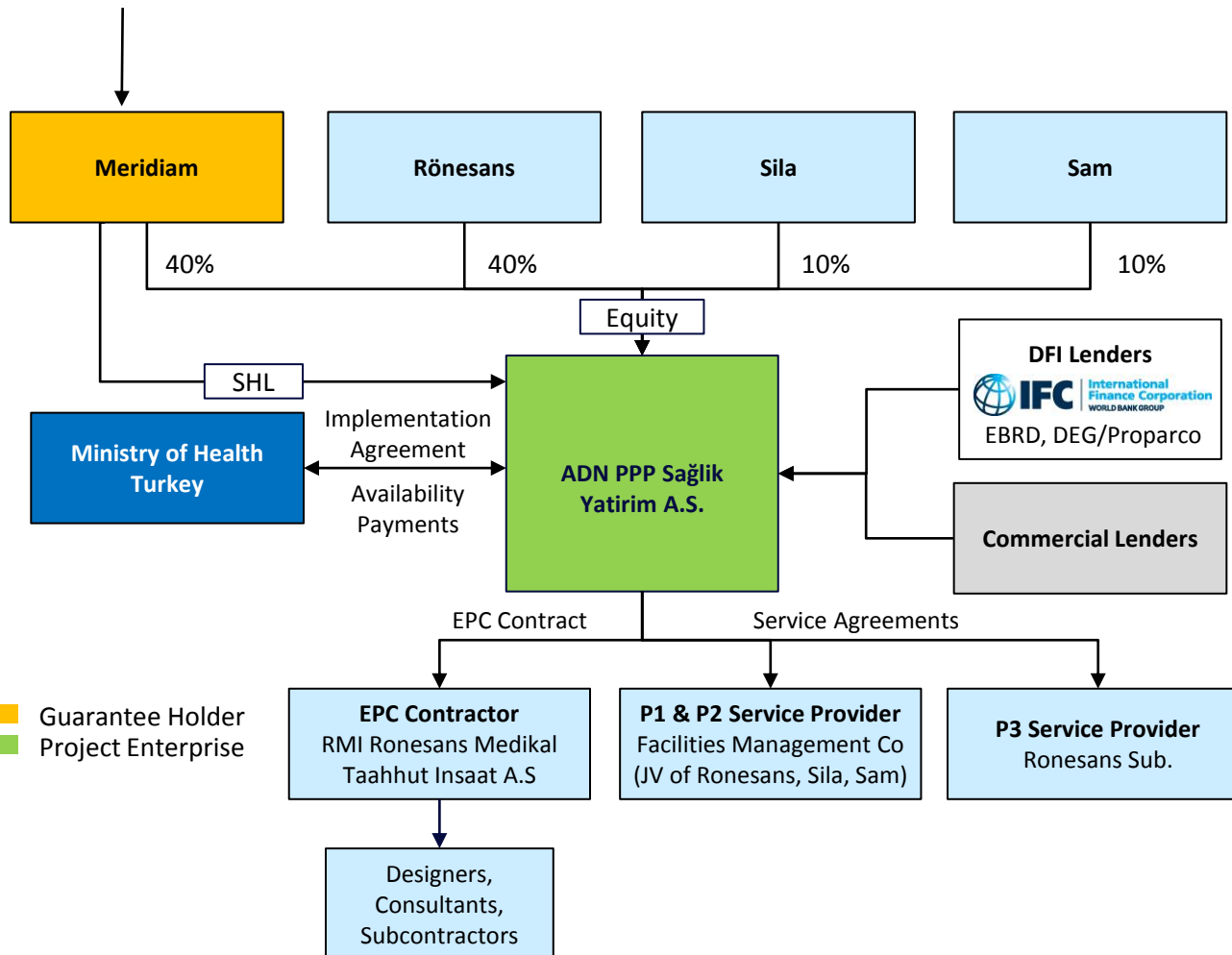

❖ **Project:** design, construction, financing, and maintenance of a new integrated health campus in the southern Turkish city Adana structured as a public-private partnership (PPP).

❖ Equity covered: \$157.5M

- Tenor: 20 years
- Issued: December 2014 2012

■ Guarantee Holder
■ Project Enterprise

Political Risk Insurance – Transfer Restriction, Expropriation, War and Civil Disturbance Cover

Elif Global Packaging S.A.E , Egypt

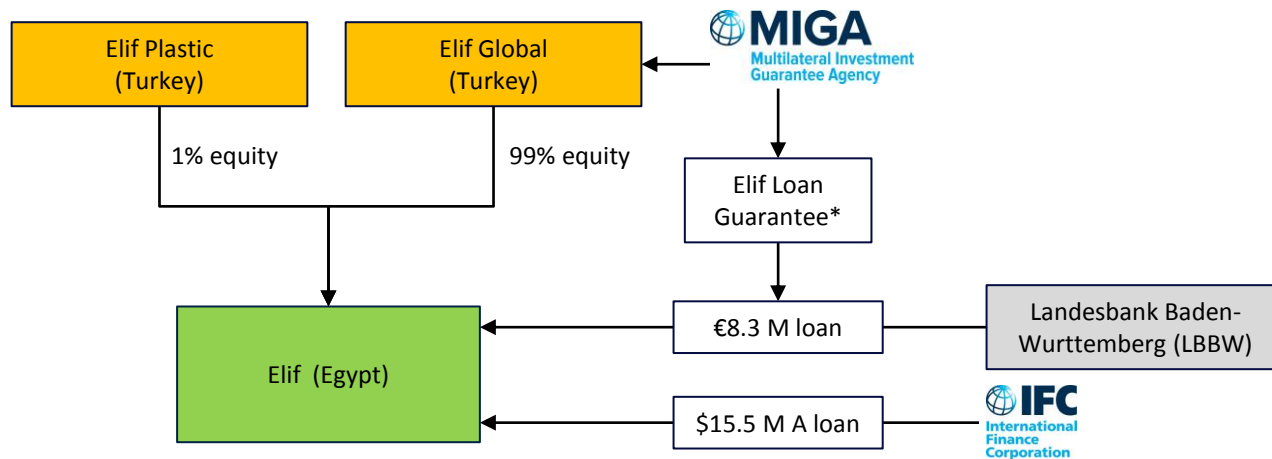

**Elif Plastik will guarantee the LBBW loan
Elif Plastik and Elif Global have jointly guaranteed the IFC loan*

- Guarantee holder
- Project enterprise

- ❖ **Project:** New packaging plant in 6th of October City's Industrial Zone with initial production capacity of 15,000 tons of plastic packaging per year
- ❖ **MIGA cover**
 - Amount: \$26.4m
 - Tenor: 15 years (equity); 10 years (loan guarantee)
 - Issued: June 2014

Political Risk Insurance – Expropriation, Transfer and Convertibility, War and Civil Disturbance; and Breach of Contract Cover

Cerro de Hula Wind Power Project, Honduras

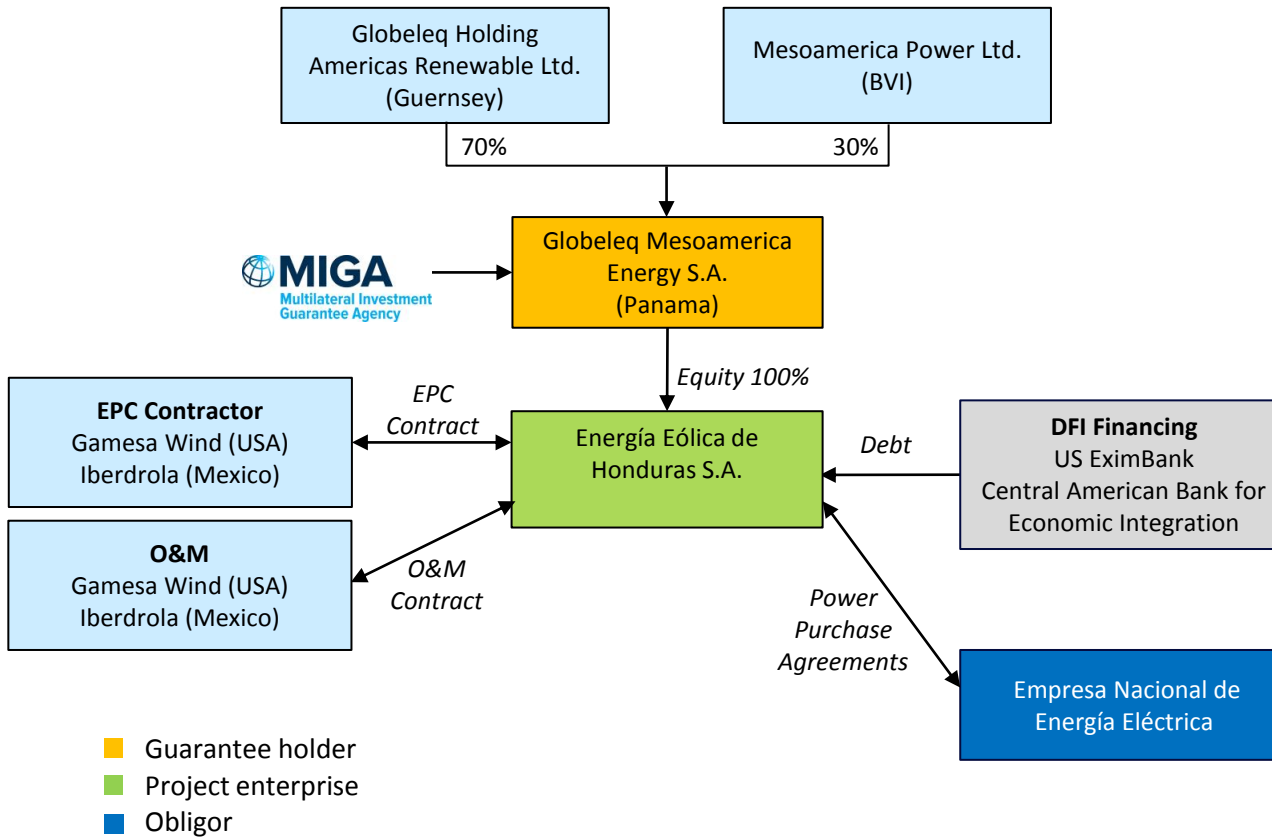

- ❖ **Project:** Support Cerro de Hula wind project including the 24 MW expansion of the existing 102 MW, 20 kilometers south of Tegucigalpa.
- ❖ Avoid 280,000 tons carbon emissions per year
- ❖ Long term Operation Agreement and State Guarantee covering the PPA with ENEE, the national utility
- ❖ Equity covered: \$82.4M
 - Tenor: 20 years
 - Issued: December 2013

Master Contract Coverage for Private Equity Investments – Transfer Restriction, Expropriation, War and Civil Disturbance, and Breach of Contract Cover

Chayton Africa, Zambia

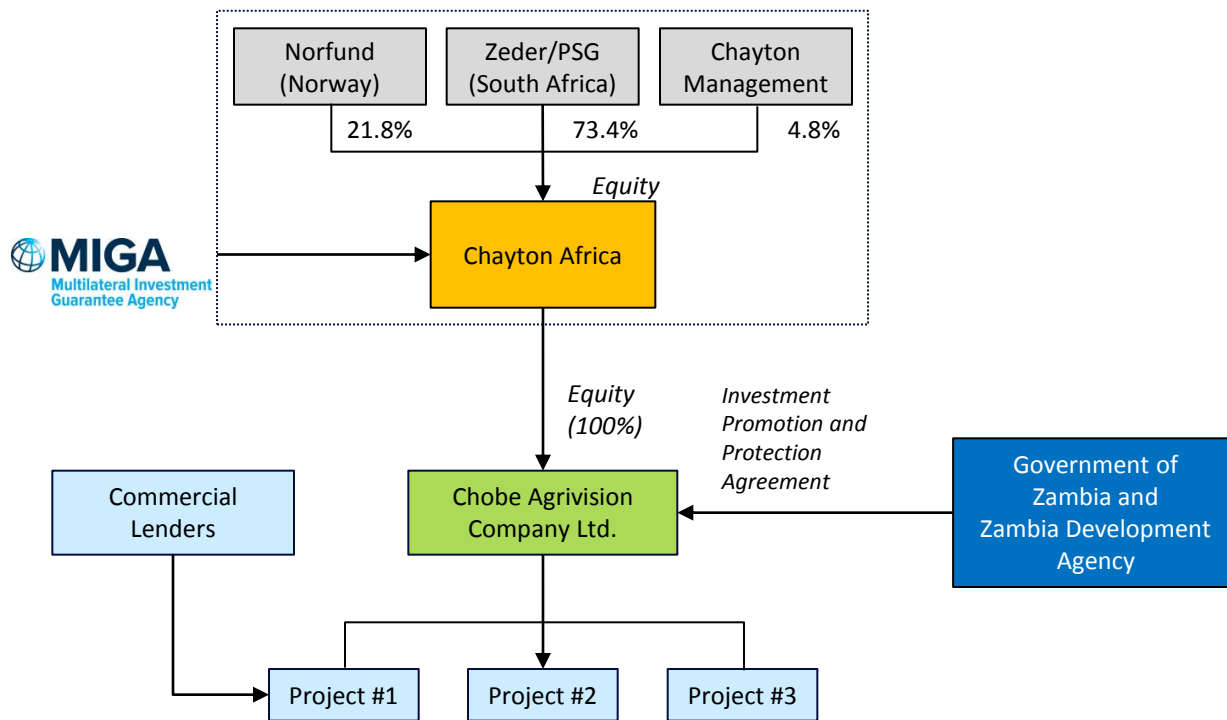

- Guarantee holder
- Project enterprise
- Obligor

- ❖ **Project:** Master contract for investments in farming
- ❖ 3-year master contract leading to 3 specific investments projects (wheat, maize, soy, and barley)
- ❖ MIGA cover
 - Amount: \$50m
 - Tenor: 15 years for specific projects
 - Issued: May 2010

1. MIGA in the World Bank Group
2. MIGA's Political Risk Insurance
3. MIGA Guarantee Examples
- 4. MIGA's Value Added**
5. MIGA's Performance

Appendix

- MIGA Underwriting Process
- Other Project Examples
- Award-Winning Projects

MIGA's Value Added

Strong pre-claim management

- Management of risks at pre-claim level (100+ pre-claims among over 750 projects. Two claims paid for expropriation, five for war and civil disturbance)
- Leveraging the World Bank network

Highly rated

- Highly rated multilateral by Basel Committee
- Reduce risk weighting and capital provisioning

Financially stable

- Strong capital base
- Mobilize reinsurance capacity

Strong Risk Appetite

- Operates in challenging markets
- Longer tenors (15 years, except for special circumstances)

Environmental and social risk mitigation

- Best practices in environmental and social standards

1. MIGA in the World Bank Group
2. MIGA's Political Risk Insurance
3. MIGA Guarantee Examples
4. MIGA's Value Added
- 5. MIGA's Performance**

Appendix

- MIGA Underwriting Process
- Other Project Examples
- Award-Winning Projects

MIGA's New Guarantee Issuance

(US\$ billion in fiscal year)

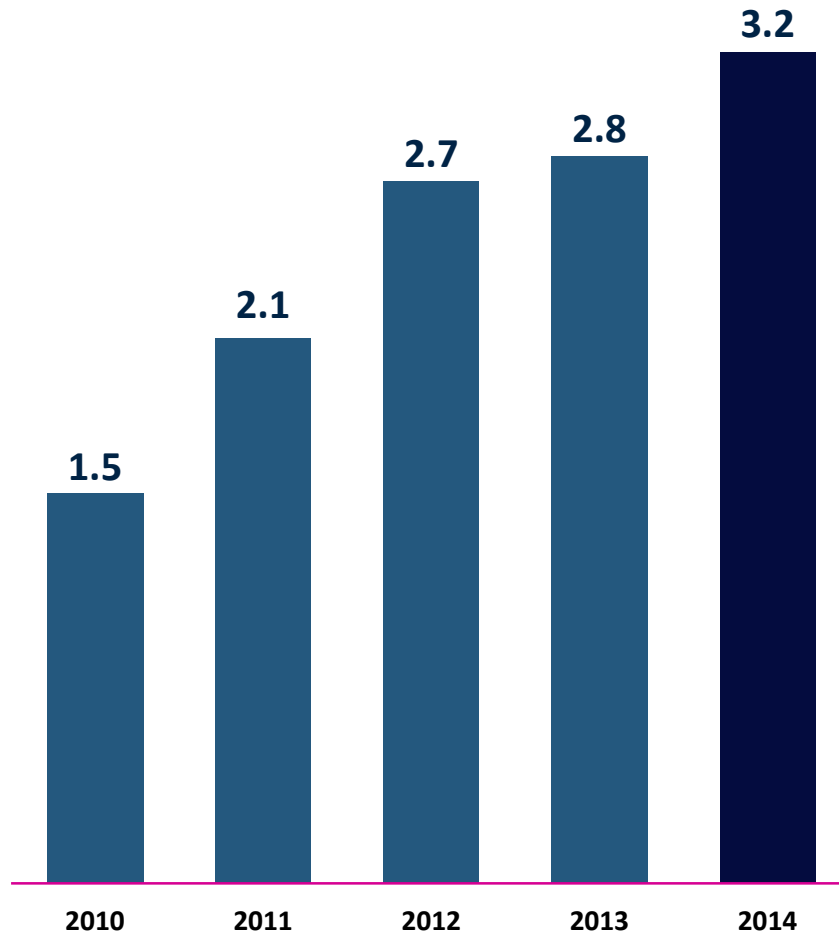

MIGA's Gross Exposure

(US\$ billion in fiscal year)

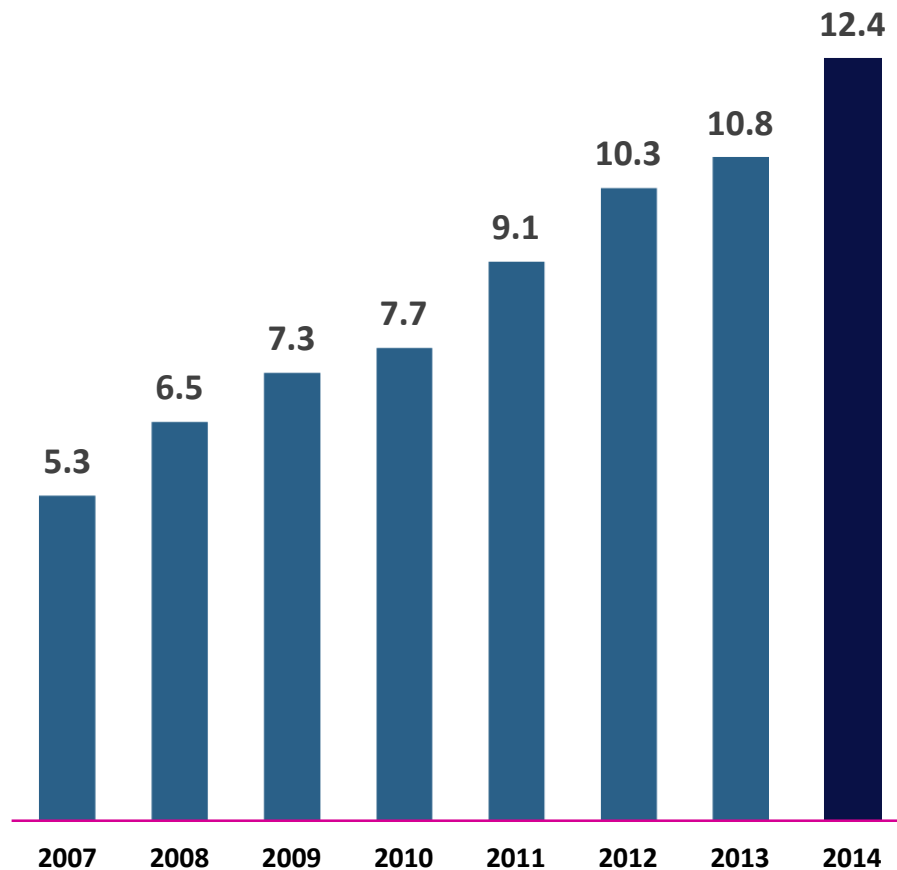

Note: CAGR (10 -14): 12.6%

❖ Supported more than **750 projects**
in **108 countries**

Expected Development Impact from FY14 projects



1. MIGA in the World Bank Group
2. MIGA's Political Risk Insurance
3. MIGA Guarantee Examples
4. MIGA's Value Added
5. MIGA's Performance

Appendix

- **MIGA Underwriting Process**
- **Other Project Examples**
- **Award-Winning Projects**

Underwriting Process

Investor

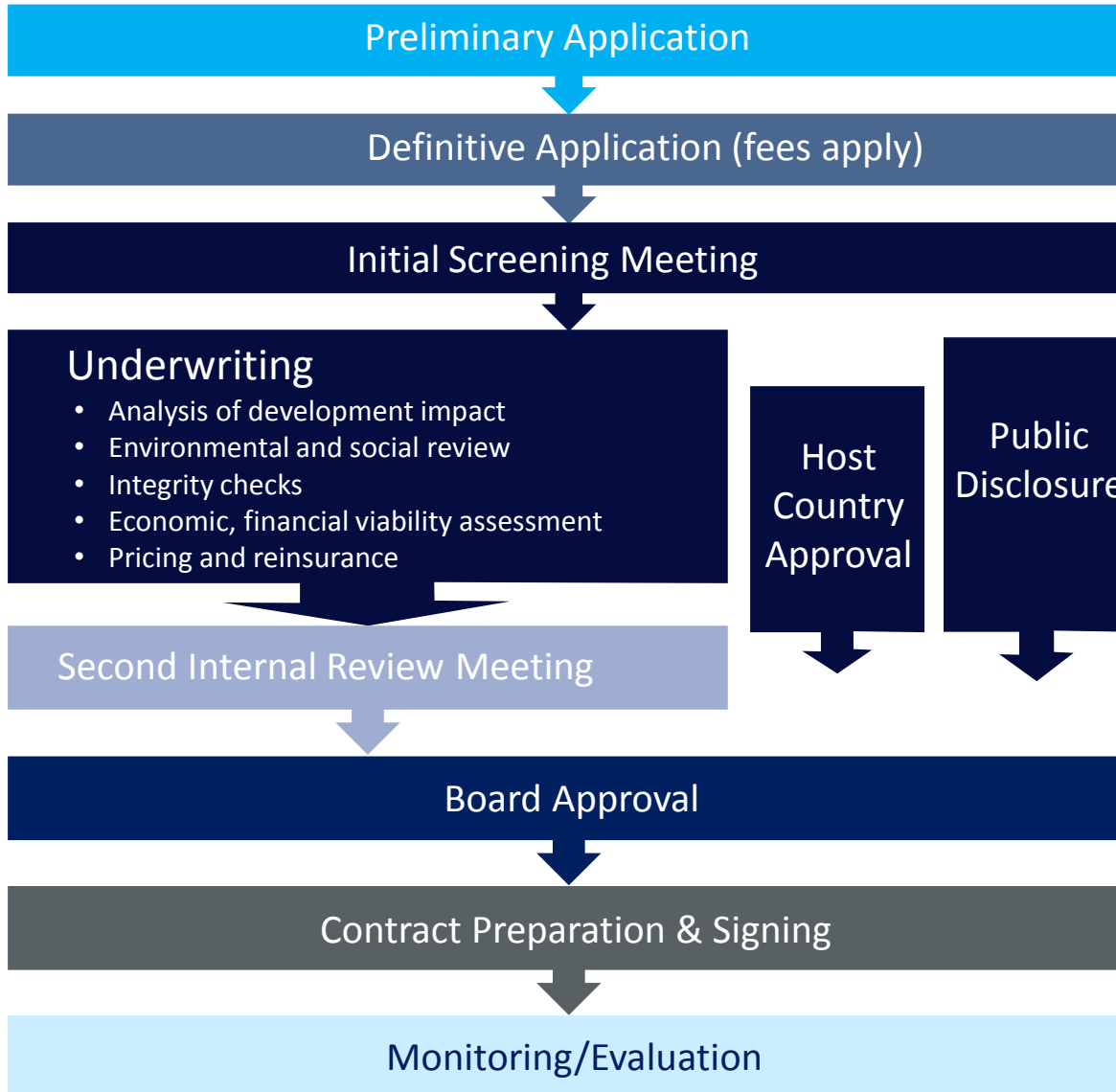

MIGA Contacts

Senior Management Team, Washington DC

Keiko HONDA

Executive Vice-President
and CEO

+1 202 473 2503

khonda@worldbank.org



Santiago ASSALINI

Director,
Finance and Risk

+1 202 458 5060

sassalini@worldbank.org



Ana-Mita BETANCOURT

Director
and General Counsel

+1 202 458 7124

abetancourt@worldbank.org



Edith QUINTRELL

Director,
Operations

+1 202 473 7723

equintrell@worldbank.org



Ravi VISH

Director,
Economics, and Sustainability

+1 202 473 8301

rvish@worldbank.org



Sector Managers, Washington DC

Antonio BARBALHO

Energy
and Extractive Industries

+1 202 473 6761

abarbalho@worldbank.org



Carlo BONGIANNI

Infrastructure (Telecoms
Transport and Water)

+1 202 473 4615

cbongianni@worldbank.org



Nabil FAWAZ

Agribusiness
and General Services

+1 202 473 8437

nfawaz@worldbank.org



Olga SCLOVSCAIA

Finance
and Capital Markets

+1 202 458 2823

osclovscaia@worldbank.org



MIGA Hubs - Asia and Europe offices

Muhamet FALL

Head – Asia Hub

+65 6517 1201

mfall3@worldbank.org



Elena PALEI

Head – Europe Hub

+33 1 40 69 31 58

epalei@worldbank.org



Selected Project Examples by Region

- 1. Asia & Pacific**
2. Latin America & the Caribbean
3. Middle East & North Africa
4. Sub-Saharan Africa

Political Risk Insurance – Expropriation Cover

Maxrise Water Services, China

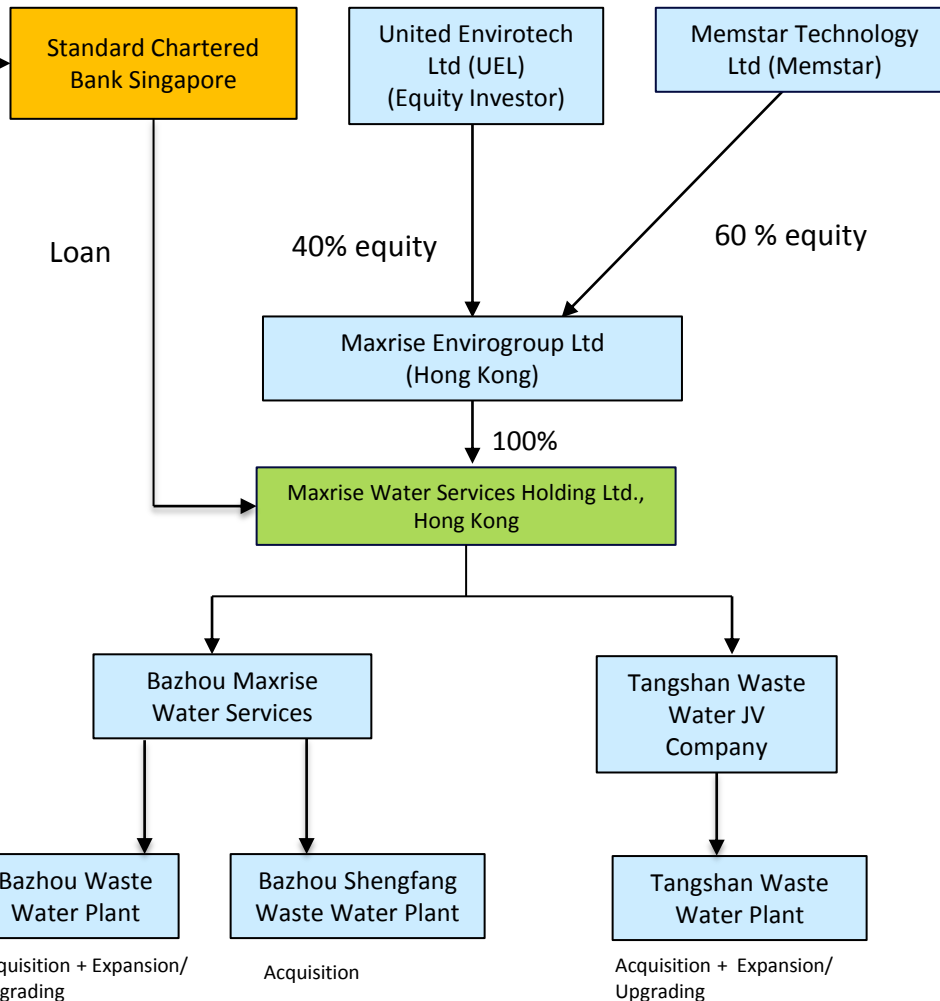

- ❖ **Project:** Acquisition, expansion, upgrading, and operation of Bazhou, Bazhou Shengfang, and Tangshan Nanpu wastewater treatment plants in the Hebei provinces
- ❖ The project is part of the local governments' plan to expand waste water treatment capacity and upgrade quality of treated water
- ❖ MIGA cover
 - Amount: \$60m
 - Tenor: 6 years
 - Issued: March 2012

Selected Project Examples by Region

1. Asia & Pacific
- 2. Latin America & the Caribbean**
3. Middle East & North Africa
4. Sub-Saharan Africa

Political Risk Insurance – Expropriation, Transfer and Convertibility, Breach of Contract, War and Civil Disturbance Cover

Cotecna de El Salvador S.A. de C.V., El Salvador

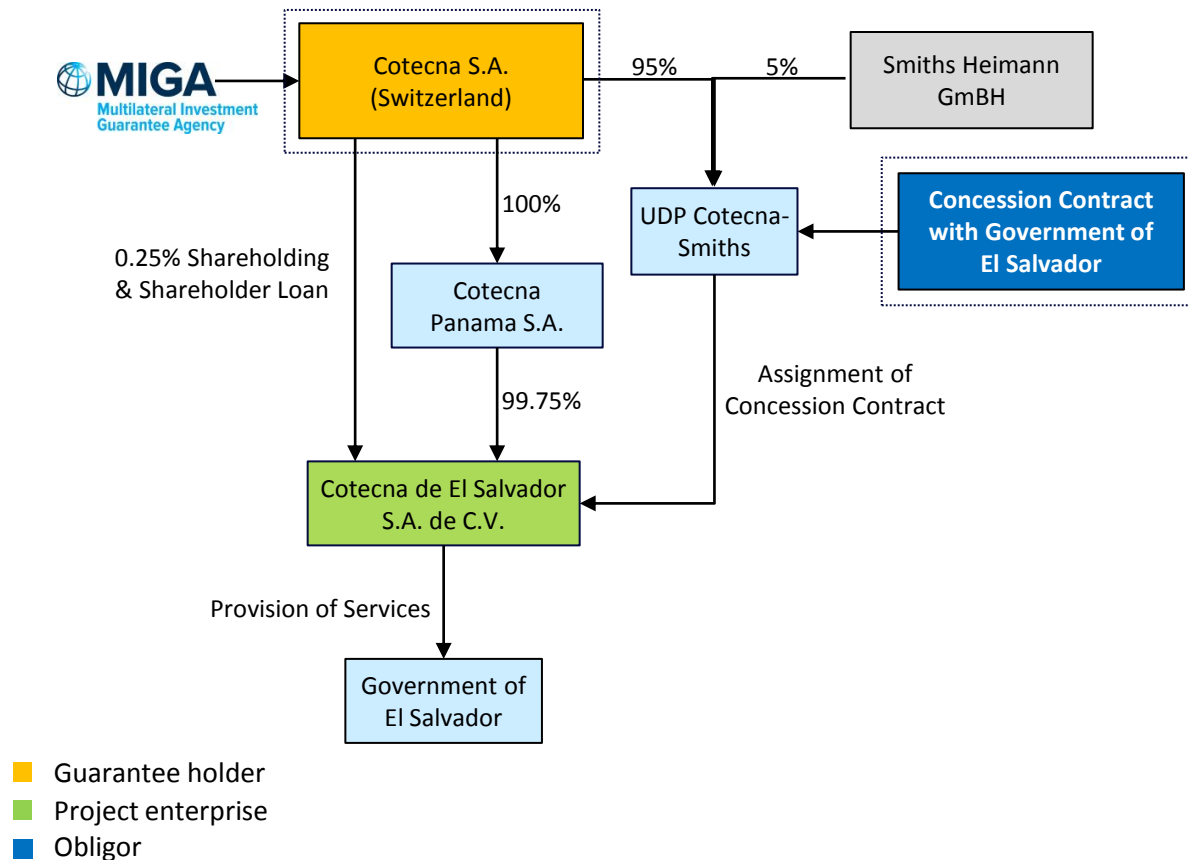

❖ **Project:** Provision of import and export verification services on behalf of the Government of El Salvador at 8 locations (ports, airports, land borders)

❖ 10-year BOT concession; increase import/export efficiency while reducing opportunities for fraud and evasion of tariffs

❖ MIGA cover

- Amount: \$23.75m
- Tenor: 12 years
- Issued: June 2013

Political Risk Insurance – Expropriation, Transfer and Convertibility, War and Civil Disturbance Cover

Eolo de Nicaragua S.A., Nicaragua

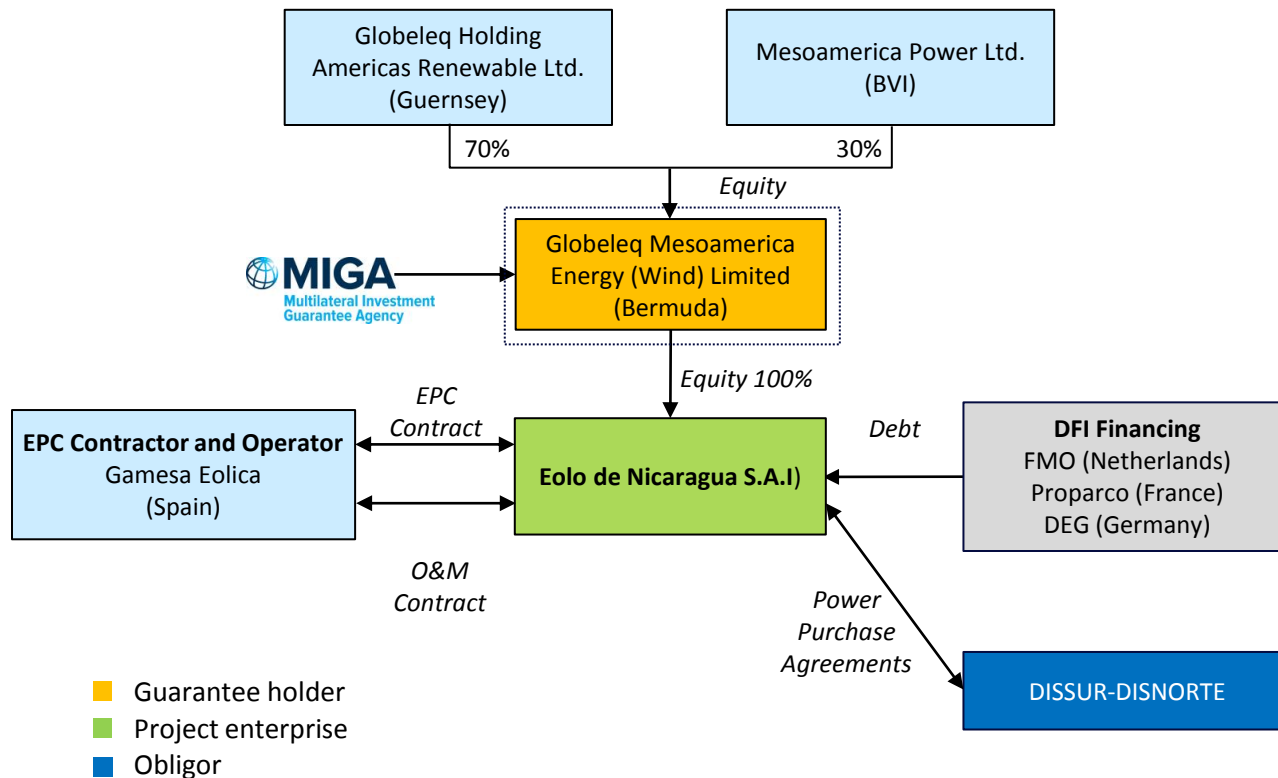

❖ **Project:** Construction and operation of a 44 MW wind farm in Rivas Province on the shores of Lake Nicaragua

❖ 30-year power generation license from Government of Nicaragua. 20-year PPA with DISSUR-DISNORTE

❖ Equity covered: \$18.1M

- Tenor: 20 years
- Issued: August 2012

Selected Project Examples by Region

1. Asia & Pacific
2. Latin America & the Caribbean
- 3. Middle East & North Africa**
4. Sub-Saharan Africa

Political Risk Insurance – Transfer Restriction, Expropriation, and War and Civil Disturbance Cover

Regional Telecom, Iraq

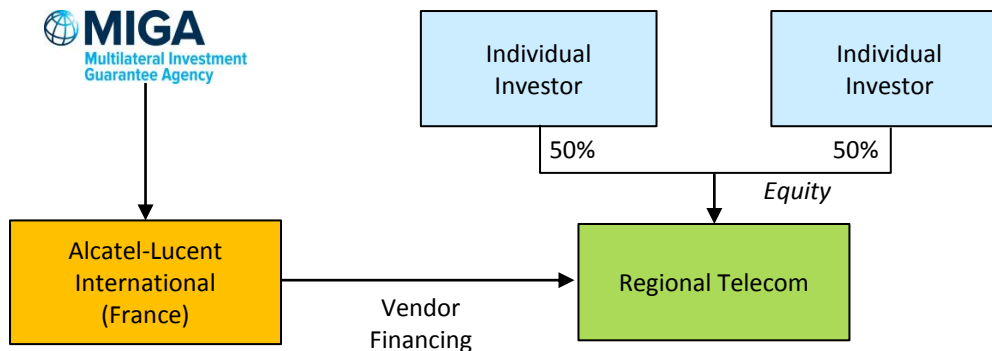

- Guarantee holder
- Project enterprise

❖ **Project:** Creation and expansion of operations of Regional Telecom, a high-speed broadband and mobile internet service provider in Iraq, financed by Alcatel-Lucent International in the form of a vendor financing facility.

- ❖ MIGA cover
- Amount: \$10.4m
 - Tenor: three years
 - Issued: October 2013

Political Risk Insurance – Expropriation and War and Civil Disturbance Cover

Albemarle and Arab Potash Company, Jordan

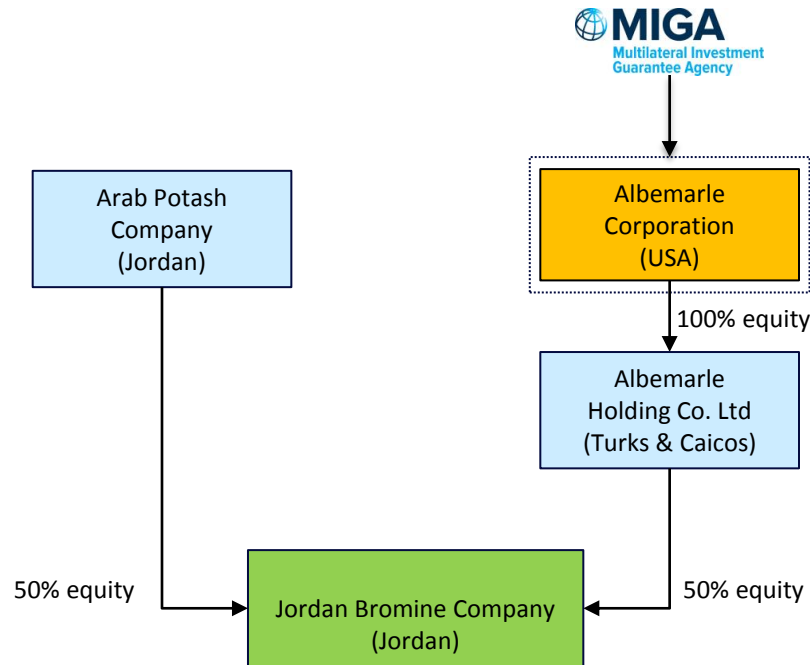

❖ **Project:** Expansion and operation of active industrial salt manufacturing plants in Jordan

❖ MIGA cover

- Amount: \$200m
- Tenor: 15 years
- Issued: June 2012

- Guarantee holder
- Project enterprise

Political Risk Insurance – Breach of Contract Cover

AS Samra Wastewater Treatment Expansion Project, Jordan

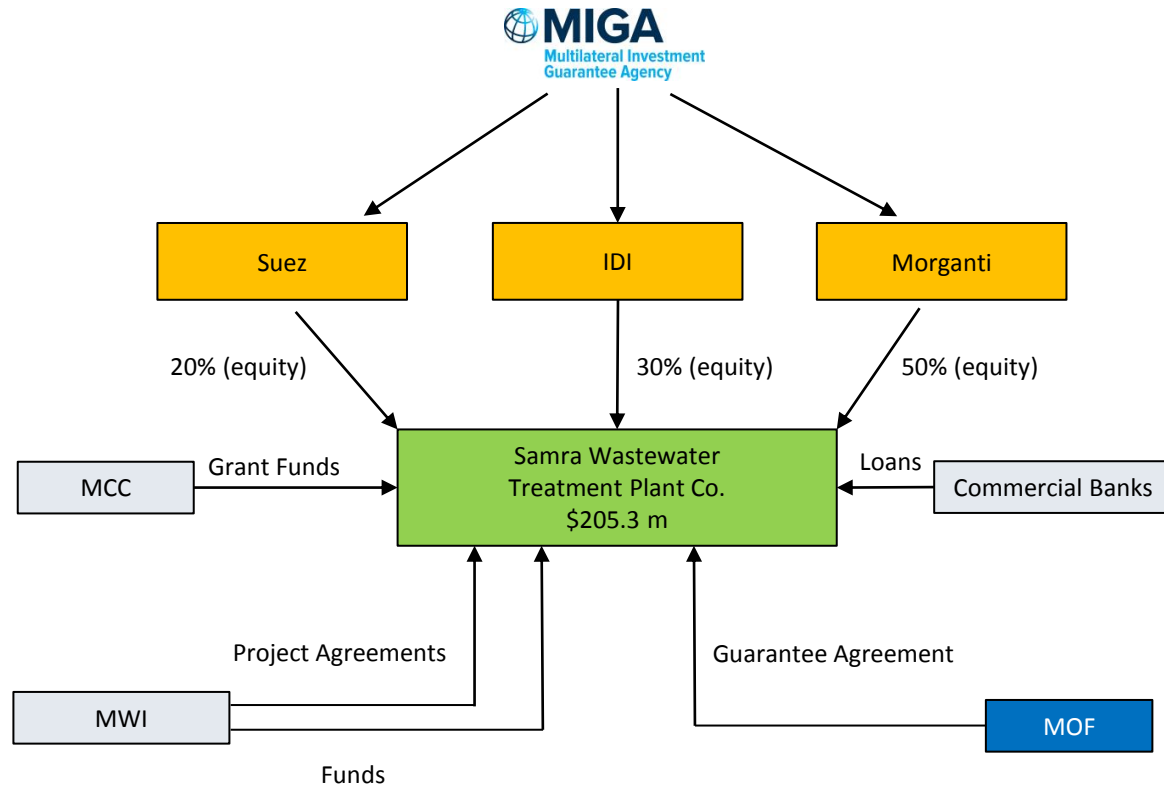

- Obligor
- Guarantee holder
- Project enterprise

- ❖ **Project:** expansion of the existing wastewater treatment plant at AS-Samra, northeast of Amman by Samra Wastewater Treatment Plant Company, Ltd.,
- ❖ **MIGA cover**
 - Amount: \$13.1 million
 - Tenor: 20 years
 - Issued: June 2013

Selected Project Examples by Region

1. Asia & Pacific
2. Latin America & the Caribbean
3. Middle East & North Africa
- 4. Sub-Saharan Africa**

Political Risk Insurance – Expropriation, Transfer and Convertibility, Breach of Contract, War and Civil Disturbance Cover

Henri Konan Bédié Bridge, Abidjan, Côte d'Ivoire

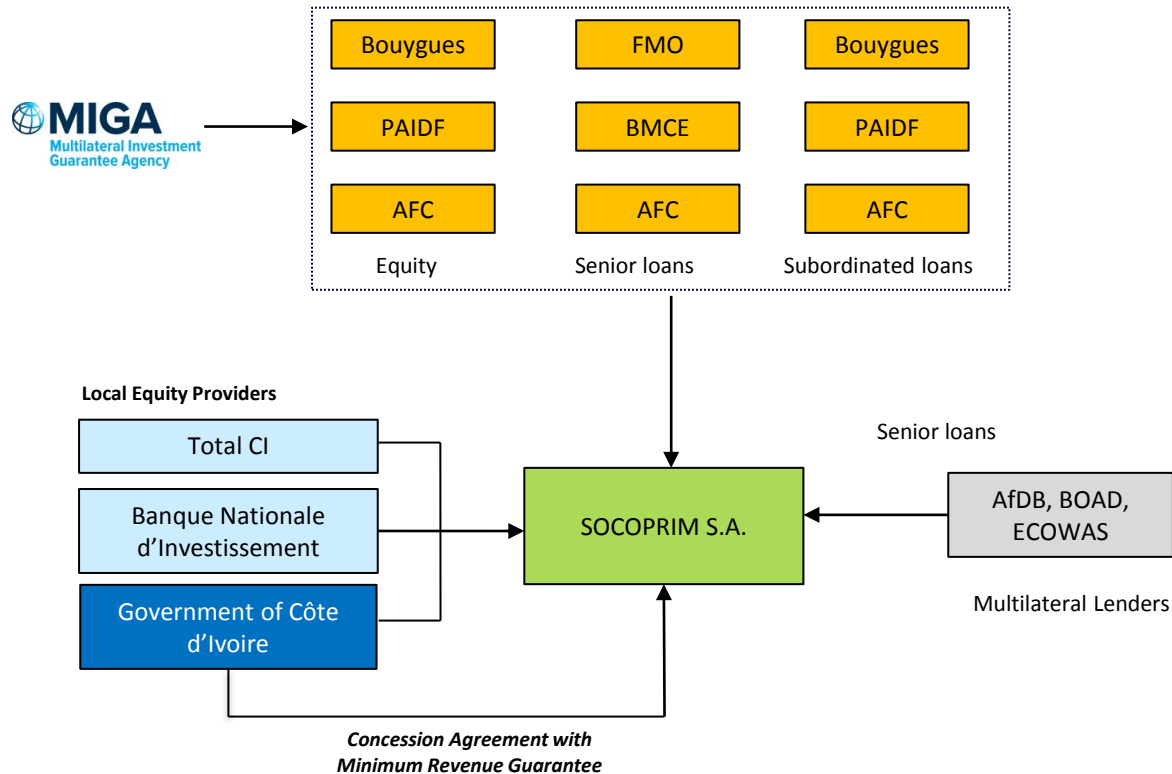

- Guarantee holder
- Project enterprise
- Obligor

Note: PAIDF = Pan African Infrastructure Development Fund; AFC = Africa Finance Corporation, FMO = Nederlandse Financierings-Maatschappij voor Ontwikkelingslanden N.V.; BMCE = BMCE Bank International Plc

- ❖ **Project:** Design, construction, and operation of a toll bridge in Abidjan, Cote d'Ivoire
- ❖ First PPP in Cote d'Ivoire since civil war and one of the first in West Africa
- ❖ MIGA covering all private sector participants in transaction on their equity and subordinated loans
 - Amount : \$145m
 - Tenor: 10-15 years
 - Issued: June 2012

Political Risk Insurance – Breach of Contract Cover

Thika Power Ltd., Kenya

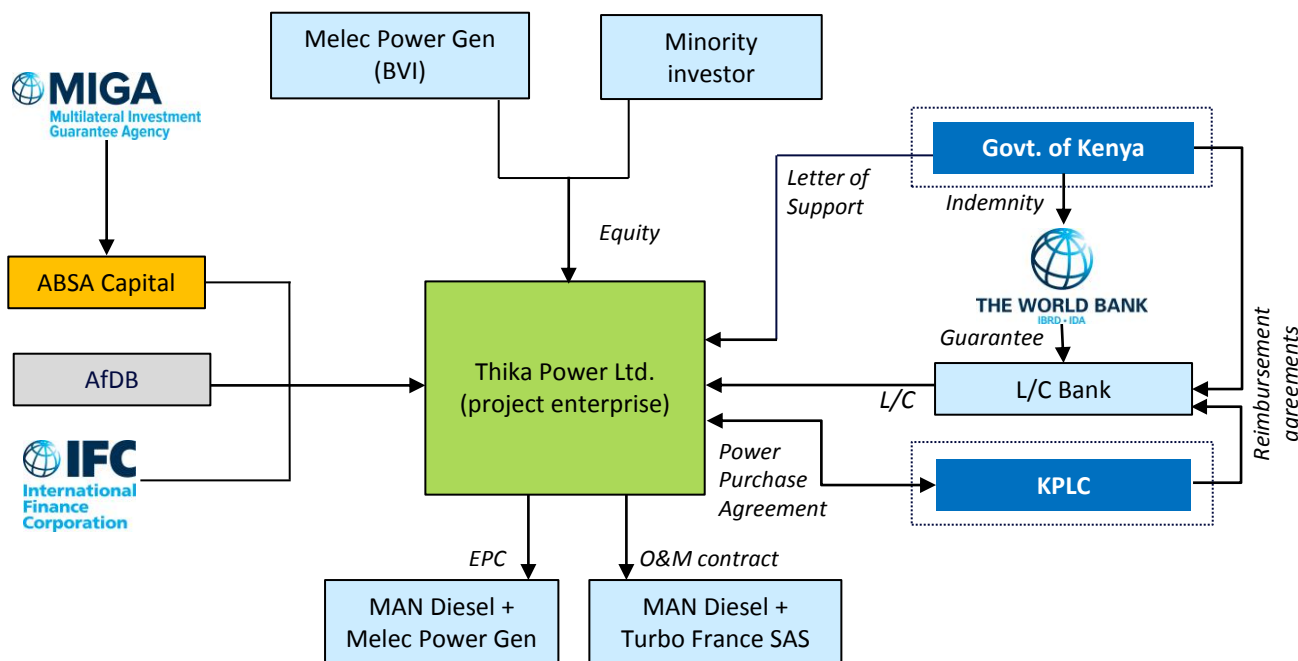

- Guarantee holder
- Project enterprise
- Obligor

- ❖ **Project:** Construction of a heavy fuel-oil plant near Nairobi (87 MW)
- ❖ 20-year power purchase agreement with Kenya Power and Lighting Co.
- ❖ MIGA cover on a loan from ABSA
 - Amount: \$62m
 - Tenor: 15 years
 - Issued: May 2012

Award-Winning Projects Insured by MIGA



Deal of the Year 2014
Trade Finance Magazine

**São Paulo Sustainable
Transport**
Brazil

\$361M
MIGA guarantee



Deal of the Year 2013
Trade Finance Magazine

Cambambe Hydropwer
Angola

\$512M
MIGA guarantee



African Power
Deal of the Year 2012
*Project Finance
International Magazine*

**Azito Thermal Power
Plant and Expansion**

Côte d'Ivoire
\$116M
MIGA guarantee



Asia-Pacific
Deal of the Year 2012
*Trade Finance
Magazine*

**Ashuganj Power Station
Company Ltd**

Bangladesh
\$251M
MIGA guarantee



Americas
Deal of the Year 2012
*Trade Finance
Magazine*

**Panama Metro
Line One**

Panama
\$320M
MIGA guarantee



Power
Deal of the Year 2012
*Infrastructure Journal
Magazine*

**Azito Thermal Power
Plant and Expansion**

Côte d'Ivoire
\$116M
MIGA guarantee



Deal of the Year 2012
Trade Finance Magazine

**Passenger-Car
Ferry TANIT**

Tunisia
\$218M
MIGA guarantee



Deal of the Year 2012
Trade Finance Magazine

Istanbul Metro

Turkey
\$409M
MIGA guarantee

Award-Winning Projects Insured by MIGA



**Beyond Business
Awards 2012**

This is Africa Magazine

Chayton Atlas Investments

Zambia
Employee and Supply Chain
Management

\$50M
MIGA guarantee

ProjectFinance

**African Transport
Deal of the Year 2012**

*Project Finance
Magazine*

Henri Konan Bedié Bridge

Côte d'Ivoire

\$145M
MIGA guarantee

ProjectFinance

**African Power
Deal of the Year 2011**

*Project Finance
Magazine*

KivuWatt Rwanda

Rwanda

\$95.4M
MIGA guarantee



**Islamic Finance
Deal of the Year 2011**

Euromoney Magazine

**PT Natrindo
Telepon Seluler**

Indonesia

\$450M
MIGA guarantee

ProjectFinance

**African Power
Deal of the Year 2007**

*Project Finance
Magazine*

Bujagali Power Project

Uganda

\$115M
MIGA guarantee

ProjectFinance

**African Transport
Deal of the Year 2007**

*Project Finance
Magazine*

Doraleh Container Terminal

Djibouti

\$427M
MIGA guarantee



**Latin America PPP
Deal of the Year 2007**
Trade Finance Magazine

Autopistas del Sol S.A.

Costa Rica

\$159M
MIGA guarantee



**Europe-RMBS
Deal of the Year 2007**
*International Securitization
Report*

BTA Ipoteka

Kazakhstan

\$427M
MIGA guarantee



miga.org



[miga-twitter](https://twitter.com/miga-twitter)



[miga-linkedin](https://www.linkedin.com/company/miga-linkedin)

INSURING INVESTMENTS ■ ENSURING OPPORTUNITIES