



ENERGIZING VISIONS



Power-Blox

WHO WE ARE AND WHAT WE DO

Power-Blox Limited is an award-winning Swiss company who develops, produces and distributes intelligent swarm electrification solutions. It has developed a ground-breaking, disruptive technology, which supported by an algorithm, allows the setup of a swarm-grid with a decentralized architecture and no centralized control (i.e. master/slave principle). This enables an automated and decentralized power regulation and storage within the grid. We call it "the internet of energy" as it follows the principles of the Arpanet. The system is self-learning and self-regulating; it regulates power production, storage and distribution in the grid intelligently and autonomously. Moreover, it allows to easily combine different energy sources and battery systems, without the need for configuration.



POWER WHEREVER YOU ARE

The **Power-Blox PBX-200**, the first product that was developed based on our swarm technology, is a revolutionary modular energy system producing alternating current from 200 Watt up to the Kilowatt range, which serves as a portable socket to off grid energy demands. Its modularity allows it to produce and easily scale electricity - similar to building blocks, by incorporating additional units to the system as energy requirements increase. The system is Plug and Power and requires no configuration, specific

know how or maintenance. It consists of intelligent energy cubes with an integrated battery (available as lead or lithium ion version). Each cube provides 200 Watt of alternating current and can be powered by a solar unit or from any external source (such as wind, hydrothermal, biomass, or a generator, etc.) to supply a household or small commercial business with electricity.

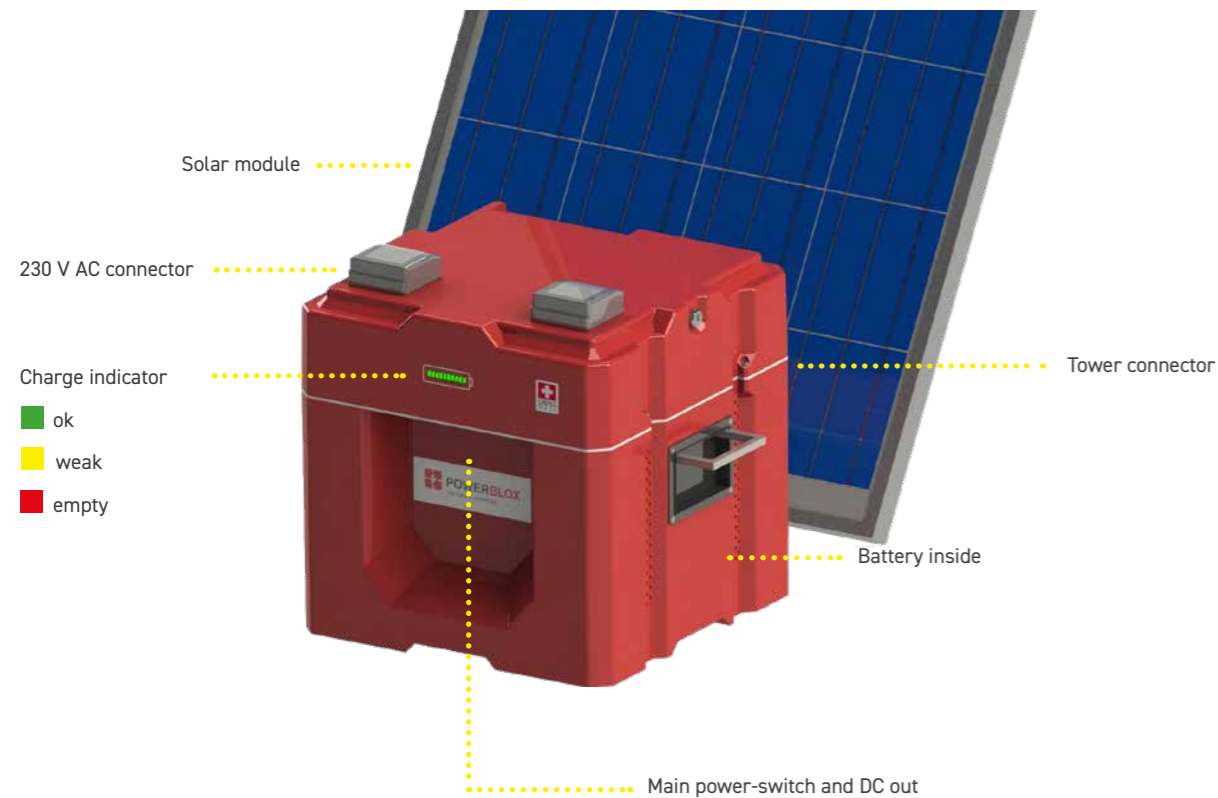

Features

- > 2 x 230 V AC/ 200 W true sinus inverter
- > 1.2 kWh solar battery
- > MPP solar charger
- > Swarm-/mini-grid enabled
- > 4x stacking sockets
- > Integrated stacking cable
- > Grid/generator connector
- > 12 V DC/3 A (cigarette lighter socket)
- > 2 x USB output

«It's Plug & Power, mobile and requires no configuration, specific know how or maintenance.»



«Its modularity allows to easily scale electricity by adding new Blox to the grid.»



POWERBLOX

«Each PBX-200 cube delivers 200 W of AC or DC power and has a capacity of 1.2 kWh»

Innovation

UNIQUE SWARM TECHNOLOGY

We believe **swarm grids** represent the next technology leap after smart grids. They reduce overall complexity as they do not need any type of data layer or communication components to deliver the same benefits as smart grids. Swarm grids manage power generation, storage and consumption with a totally different approach than smart grids. They use a fully decentralized architecture to manage fluctuating current, while smart grids need a centralized architecture to steer power generation and storage. In a swarm grid, every component of the grid learns how to adapt to the current state of the grid by observing the grid parameters and adapting its behaviour with the use of artificial intelligence.

The decentralized approach of swarm grids has many advantages over smart grids: it improves the stability and reliability of the grid; at the same time, it massively reduces vulnerability, for instance against cyber threats, as it eliminates the need for a data layer. Swarm grids are also more cost effective since there is no need for data and communication components to achieve the same benefits as a smart grid. Moreover, swarm grids enable hot plug functionality for energy sources, battery systems and consumers. At present, all the power grids we are familiar with require active and centralized power regulation via a central controller and/or operator. We therefore believe that this technology has the potential to become a standard in the energy industry as a universal energy interface.

«Swarm grids reduce the grid's overall complexity while delivering the same benefits as smart grids»

- › Swarm grid based on Power-Blox in Rwanda.



Infinite scalability with the power of the swarm

FROM ONE UNIT TO A WHOLE VILLAGE



Stand-alone

- › Instant Plug & Power of 200 W, directly supplies 230 V AC
- › Optional provided solar unit
- › Works with various external energy sources

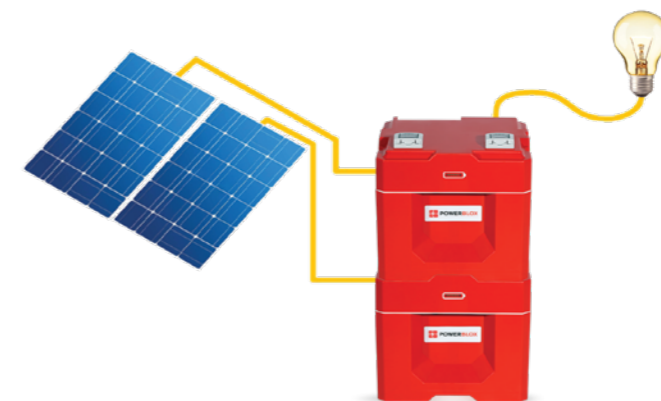

Stacking

- › Modular expansion allows to produce and easily scale electricity according to needs
- › No configuration needed

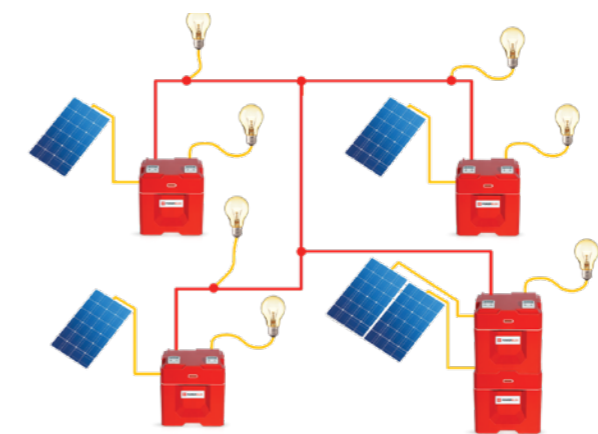

Swarm-Grid

- › No Master-Slave setup; the grid works completely decentralized
- › The whole mini-grid works stand-alone
- › More units increase the stability and power of the grid
- › Every consumer in the system can still use the full power of all units

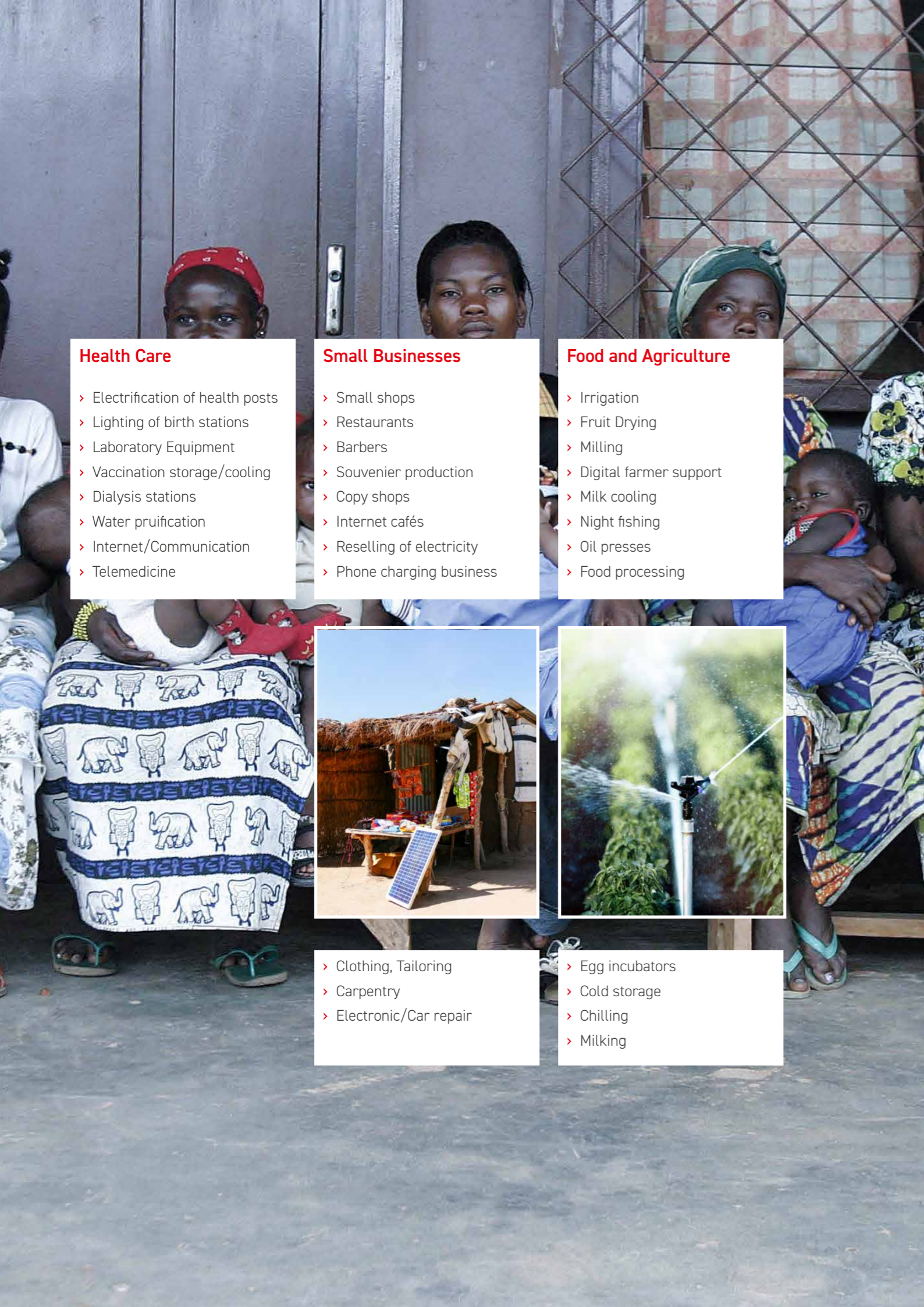

Health Care

- > Electrification of health posts
- > Lighting of birth stations
- > Laboratory Equipment
- > Vaccination storage/cooling
- > Dialysis stations
- > Water purification
- > Internet/Communication
- > Telemedicine

Small Businesses

- > Small shops
- > Restaurants
- > Barbers
- > Souvenir production
- > Copy shops
- > Internet cafés
- > Reselling of electricity
- > Phone charging business

Food and Agriculture

- > Irrigation
- > Fruit Drying
- > Milling
- > Digital farmer support
- > Milk cooling
- > Night fishing
- > Oil presses
- > Food processing



- > Clothing, Tailoring
- > Carpentry
- > Electronic/Car repair



- > Egg incubators
- > Cold storage
- > Chilling
- > Milking

Applications

LEVERAGING IMPACT

Education

- > Electrification of schools
- > Lighting of classrooms
- > Electrification of computer rooms
- > Digital learning
- > Overhead projectors
- > Internet infrastructure



Civil Services

- > Electrification of health posts
- > Electrification of rural police stations
- > Fire stations
- > Voting stations
- > Border stations



Wildlife Preservation

- > Digital wildlife surveillance
- > Radio charging
- > Communication

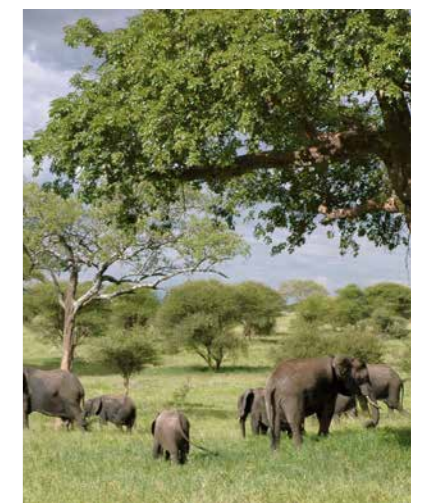

That's why investors love us

IMPACT HAS NEVER BEEN FASTER

Where traditional mini grid projects need a long and costly evaluation and engineering phase, Power-Blox can be installed almost instantly. Real time consumption data help to verify the business model and to analyse the energy needs. Start with just a few cubes to get meaningful insights during the pilot-phase and scale up to a theoretically unlimited size with growing energy demand. Thus you do not only minimize

and mitigate your investment risk but at the same time secure your initial investment as Power-Blox's scalability ensures the continued use of the existing devices, that can be supplemented with additional devices over time. In conventional systems some of the components have to be replaced when the grid grows.

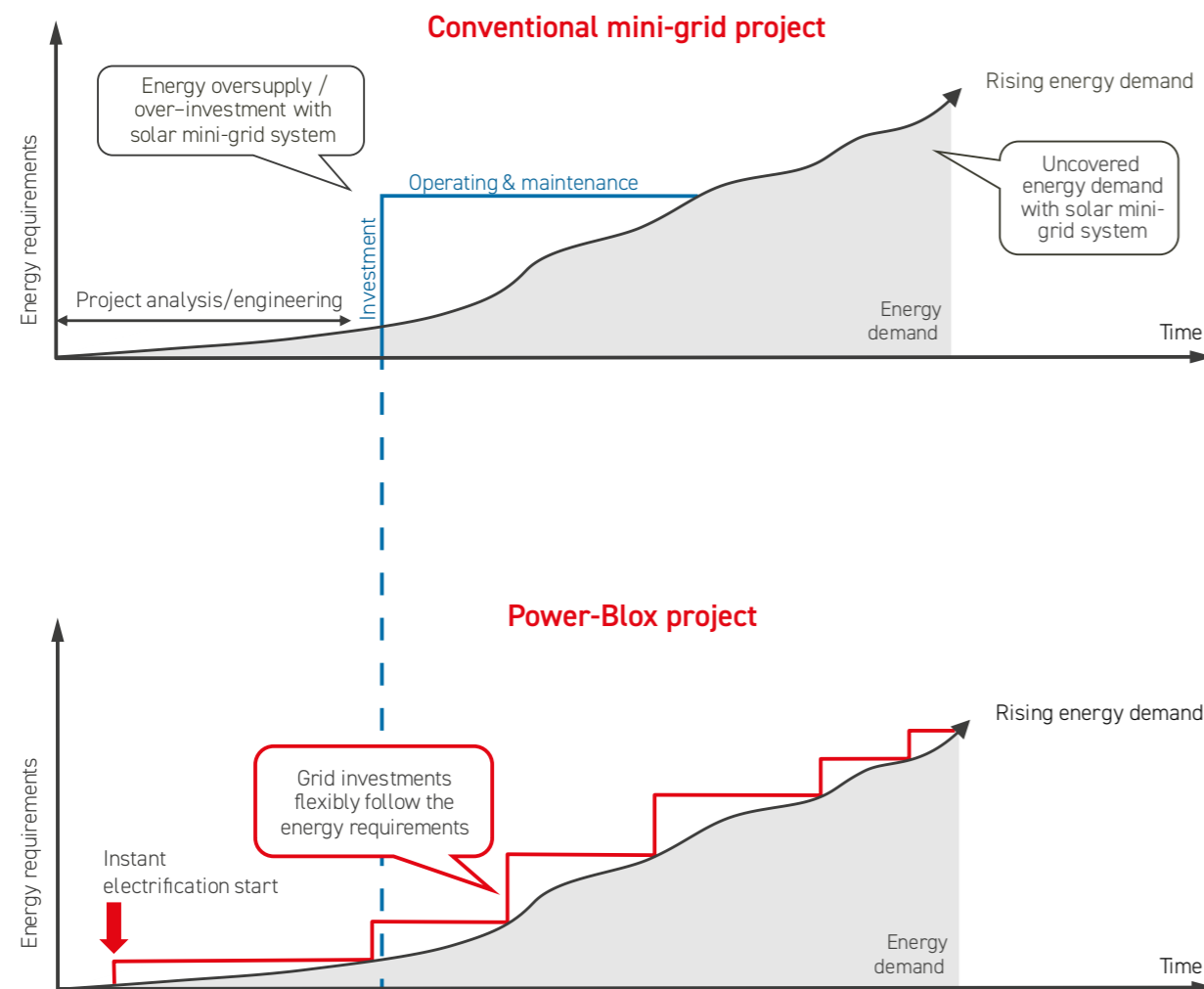

« The system was installed in two days for less than one third of the costs of conventional solar power. Future growth will cover all households in the community and more importantly increase the power capacity by easily and quickly adding new cubes.»

> Alexandra Soezer, Climate Change Technical Advisor at UNDP's Nationally Determined Contribution Support Programme;
Source: https://www.pacific.undp.org/content/pacific/en/home/blog/2019/Frugal_Innovation.

> The grid can grow over time without any replacement costs.

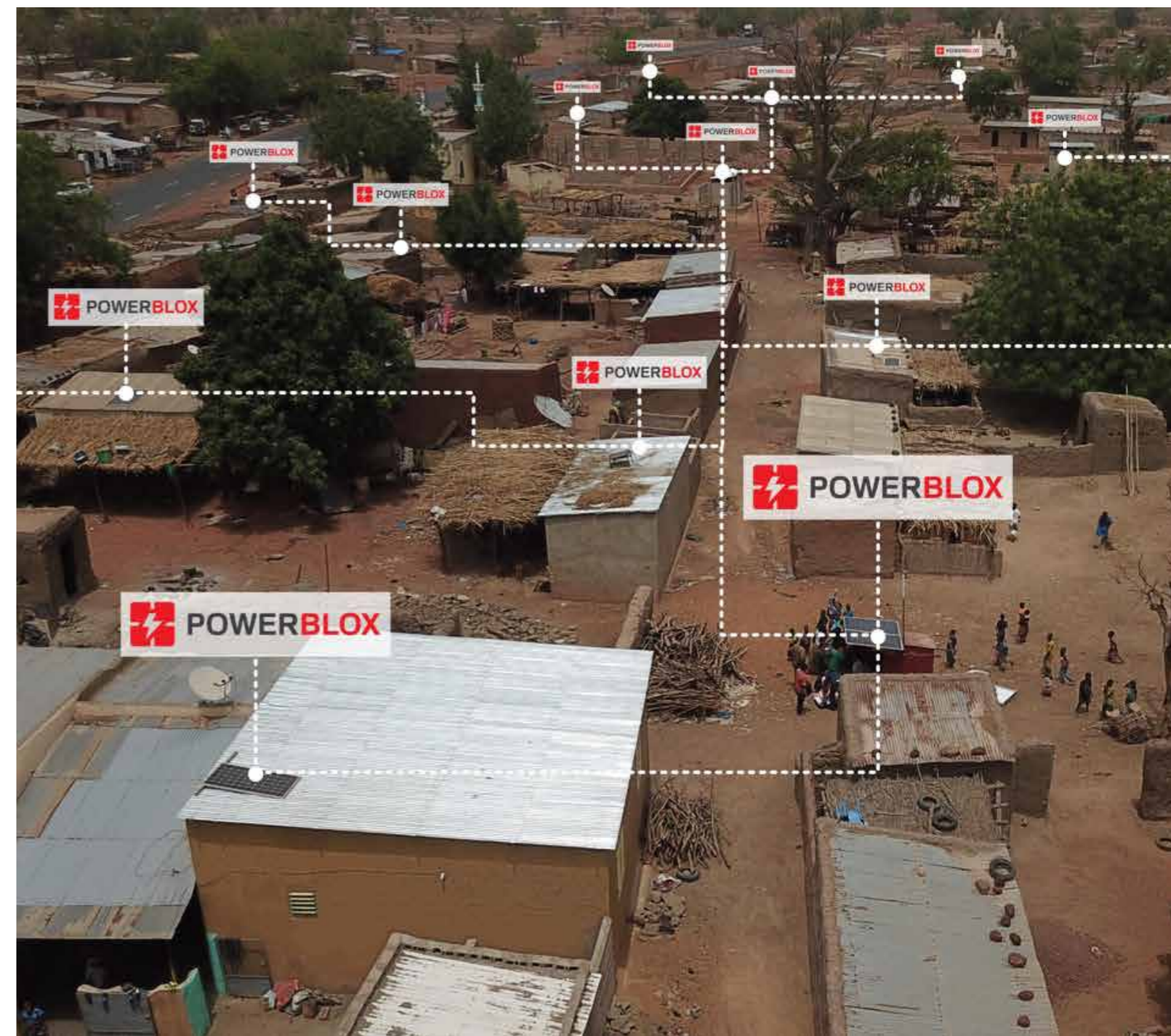

*An opportunity to democratise electricity by
Alexandra Soezer*

FRUGAL INNOVATION

«The highest impacts in developing countries are achieved with technology solutions that are easy to use and widely accessible, not those created to impress customers» – this statement comes from Navi Radjou, Innovation Strategist from the Silicon Valley. Navi points out that the Global North is learning from the South by doing better with less in a resource constrained world, through horizontal solutions with low-priced, smaller distribution units as opposed to centralised operations in big factories. These bottom-up solutions will help to bring the global North and South closer together. The term now widely used for such approaches is frugal innovation: solutions are born out of necessity in the Global South where resource constraints force people to do more with less.

Introducing a new technology on Lelepa Island

Recently, I had the opportunity to witness the impact of an example of frugal innovation.

The off-grid island of Lelepa in the Republic of Vanuatu, located in the South Pacific Ocean, has just started trialing a modular energy solution called Power-Blox. Power cubes with a modular design and grid-connectivity, much like blocks of Lego, allow for expansion and growth of the grid over time and at the pace needed by the rural community, while delivering all the other benefits that come with renewable energy, largely through improving livelihoods without damaging the environment. The more blocks you add, the more energy you get, and the stronger the so-called swarm grid becomes.

It's the first-ever introduction of a swarm technology in the Pacific region with the goal to create solutions that speak to the communities in an unprecedented way. Instead of compromising on quality and performance,

› Paramount Village Chief Reuben Natamatewia with the catch of the day.





› Little paradise and part of a UNESCO's World Heritage: Lelepa island.

the technology provides a more affordable solution that is easy to use, at the same time offering maximum performance and quality. Using and maintaining the power cubes is «as simple as a breeze», according to Brownie Billy, locally trained technician on Lelepa Island.

A learning path to innovation

Seeing costly installations of other technologies in the Pacific made me wonder if we will ever be able to achieve Sustainable Development Goal SDG 7 - affordable and clean energy not to say by 2030, I learned about a humble team of innovators that had carefully listened to the people in the Global South. With years of experience, learning and experimenting in Eastern Africa, a 'swarm technology' was created. The technology introduced to these 'overlooked' consumers, is a power system that starts small for those communities with little ability to pay but allows for almost unlimited upscaling with increasing wealth. Swarm grids are strong and sustainable because they don't depend on the usual master-slave setup of electricity grids. Each power cube is its own independent system, and lowered performance of one cube will immediately be compensated by another element of the swarm.

I saw the happiness and astonishment of the community on Lelepa Island after the pilot installations were completed. Quickly, I realised that we are on the right track. The cubes are technically so easy to handle that no lengthy training was needed to ensure someone like Brownie knows how to handle the Power-Blox. A mobile application allows the inventors to follow the performance closely and make corrective actions remotely, if necessary. This, however, is only needed in this initial phase, as the cubes are designed for full local maintenance. A local power supplier company was engaged in the setup and can troubleshoot without having to reach out overseas.

Simple solutions with high socio-economic impacts

The system was installed in two days for less than one third of the costs of conventional solar power systems. Since it is built as an expandable swarm system, future expansion will not only cover all households within the community, but even more importantly increase the power capacity by easily and quickly adding new cubes. Vanuatu's rural island population consists - like many other rural communities around the world - of subsistence farmers or fishers without regular income. The

› Mangos everywhere and far too many to eat or sell.



«Thank you, Power-Blox! Stable electricity is the first step into a great future for Lelepa island.»

› Reuben Natamatewia, Paramount Village Chief, Lelepa Island

productive use of electricity in the community will increase income, create jobs, reduce poverty and generate more electricity demand. These typical growth patterns after electrification of off-grid communities require flexible systems that can adapt to the changing energy demands. Systems just like Power-Blox. The Government of Vanuatu is planning to introduce the swarm technology to several island communities across the country.

Removing barriers to energy access

Communities in remote, scarcely populated areas of the developing world simply cannot afford to consume enough electricity to develop robust and fully bankable renewable energy investments. For this reason, international organisations, development banks, foundations and donors are all searching for financially feasible de-centralised solutions to implement renewable energy solutions at scale. These organisations, however, are known for slow implementation pace and overly complicated project approval and development processes. It is clear that SDG 7 will not be achieved with such a donor-heavy, slow-paced approach. Innovation may well be the key to success – a success that can address low but increasing demand of rural communities, while promoting productive use of energy to develop and expand the grids. Technology solutions that don't overburden communities and force men and women out of village structures to earn money elsewhere to cover the costs of unsustainable electricity bills. Technology that allows communities to create new livelihoods within their safe social structures, at their own pace. It's a true democratisation of electricity. No more inflexible systems that lock consumers into unsustainable fee structures. No more under-consulted and underserved communities. With Power-Blox, Lelepa sets an example of how systems with maximum flexibility and affordable fee structure the potential has to quickly create wealth and happiness, at scale.

› Transparency through cloud-based monitoring.



Case Study – Police Stations in Angola

ELECTRIFYING POLICE STATIONS

Mobility, installation, operation and maintenance without expert knowledge as well as flexible adaptation of the power supply to local infrastructure and equipment of police stations are only some of the requirements relevant for the electrification of a mobile police station.

Power-Blox opens up this possibility for local authorities. Local police stations can optionally be equipped with three to six PBX-200 depending on the power requirements. In a first pilot project the National Police Station Detachment S/B, Cabolombo, Luanda, was electrified and equipped with four Power-Blox and the corresponding PV system. The electrification

represents a major step for modern police work. Identity checks, database queries and the communication possibilities for officers have been improved significantly. The operation of an air conditioning system and the lighting also considerably improve the working conditions on site. In addition, every police station was equipped with an online gateway to enable 24/7 monitoring. The concept though is not limited to police stations. It can be extended to almost all areas of public services. From customs controls to voter registration in rural areas to the electrification of fire stations, the possibilities for improving and providing public services are almost limitless.



› Mobile Police Station in Angola



Case Study – Swarm Electrification and Smart Metering

FLEXIBLE MICRO GRIDS

When we take a closer look at electrification in rural areas of developing countries, it becomes increasingly apparent where the solutions adopted so far are already working well and where there is a need to catch up. It is true that some factors like regulatory frameworks are beyond the control of technology companies. In other areas, such as financing options, the situation for sustainable off-grid energy projects has changed.

Nonetheless, most of the «low hanging fruits» that can be covered by existing technologies have now been implemented. But 13% of the world's population still has no access to modern energy. It is therefore necessary to analyse what hinders rapid electrification and how these obstacles can be minimized. With over 12 years of experience in rural electrification projects, we identified a solution gap in the important segment of energy solutions around a few kilowatts. This power range is neither covered by DC based solar home systems nor addressed by the mini-grid industry. However, it is precisely in this area that such important development drivers as farmers, small businesses, schools, health centres and many others can be found.

Although there have been attempts to cover some segments of this customer group with application-

centred solar solutions, we believe that those solutions will remain niche products, that will never achieve the market share necessary to achieve large-scale impact.

Power-Blox is therefore focussing on universal application coverage in the segment of the one to two-digit kilowatt range. This means that we create solutions for nano-grids with our swarm-based, modular solar storage systems in combination with standard application equipment (freezers, refrigerators, LED lamps, grain mills, medical laboratory equipment, etc.). Since our solutions are scalable, these nano-grids are considered as crystallization points for the micro-grids growing from there. We are currently testing and improving this approach in several pilot projects in Angola, Mali, Rwanda, Zambia, Uganda, Vanuatu and Laos.

An important aspect of our approach, which we are co-developing with partners such as Flex-Grid Mali, is the integration of smart metering systems, usually on a pay-as-you-go or lease-to-own approach. These approaches include affordable tariff models and the measurement of the impact achieved. Since households, small businesses, farmers and institutions are metered individually, meaningful load profiles are obtained. By applying machine learning algorithms (AI) and random sampling at real customers, our programs learn about the socio-economic development of these households, companies and institutions. The result is a well-supported conclusion on the impact achieved with the investment. In turn this is valuable information for NGOs or impact investors, which are measured by the efficiency of their engagement.



› Power-Blox supplying electricity in a emergency shelter on Sulawesi



« PBX-200 were used for the chlorine production for water purification.»

Supplying Electricity where it's needed most

HUMANITARIAN AID

On 28 September 2018 an earthquake measuring 7.5 on the Richter scale hit the Indonesian island of Sulawesi. The earthquake triggered a tsunami that devastated large parts of the city of Palu and other places along the coast. The earthquake and the tsunami claimed over 3400 lives and made more than 220'000 people homeless.

In consultation with the Indonesian government, Swiss humanitarian aid sent an emergency team to treat drinking water and provide emergency shelters. The humanitarian aid experts had PBX-200 on board because the local power supply on Sulawesi had collapsed and fuel was very scarce. Thanks to the Plug and Power features, the PBX-200 were able to start operating quickly on site. The local partners in the catastrophic area were trained in chlorine pro-

duction for water purification (WATA), the energy needed for chlorine production was supplied by the PBX-200. They also supplied electricity for laptops, mobile phones, computers, printers and the mobile water testing laboratory - all essential for successful disaster relief. The use of PBX-200 for water purification was developed within a public-private partnership between Power-Blox and Swiss Humanitarian Aid, which is part of the Swiss Agency for Development and Cooperation. Launched in 2017, the cooperation shows how development experts and private actors can develop innovative technological solutions.



› Power-Blox are loaded into a Swiss Air Force aircraft in Switzerland for the flight to Indonesia.

« PBX-200 supplied electricity for laptops, printers, mobile phones and the mobile water testing lab.»

› Water purification workshop in Sulawesi. PBX-200 supplied electricity for the chlorine electrolysis.



› All photographic material courtesy of © SDC



From 200 Watt to the low Megawatt range

ENERGY SOLUTIONS FOR THE FULL POWER RANGE

Power-Blox can serve the whole power range. From a single application to the low Megawatt range. The areas of application are almost unlimited.



200 W ... 8 kW

8 kW ... 40 kW



Health Centers



Schools



Small Businesses



Civil Services

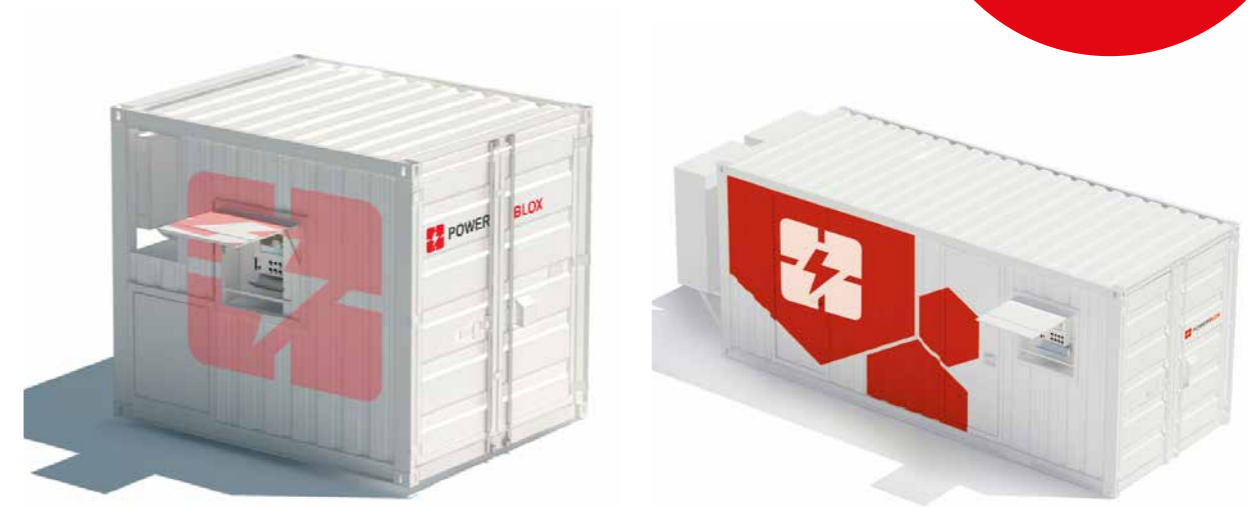

40 kW ... 120 kW

120 kW ... 2 MW+



Food Processing



Telecommunication



Backup Power



Mining

Vast areas of application!

Our approach

PLUG & POWER - SCALING UP TO INDIVIDUAL NEEDS

Power-Blox provides a highly scalable Plug and Power energy solution that is compatible with numerous energy sources as well as energy consuming goods for daily use cases and emergency relief situations.

Our approach does not end with the implementation of the pure power supply. Rather, we strive to promote impulses for the socio-economic development of local communities through productive use. On Lelepa Island, for example, freezers are operated with Power-Blox. This enables local fishermen to conserve their daily catch and no longer have to commute daily to the main island to sell their catch at the local fish market.

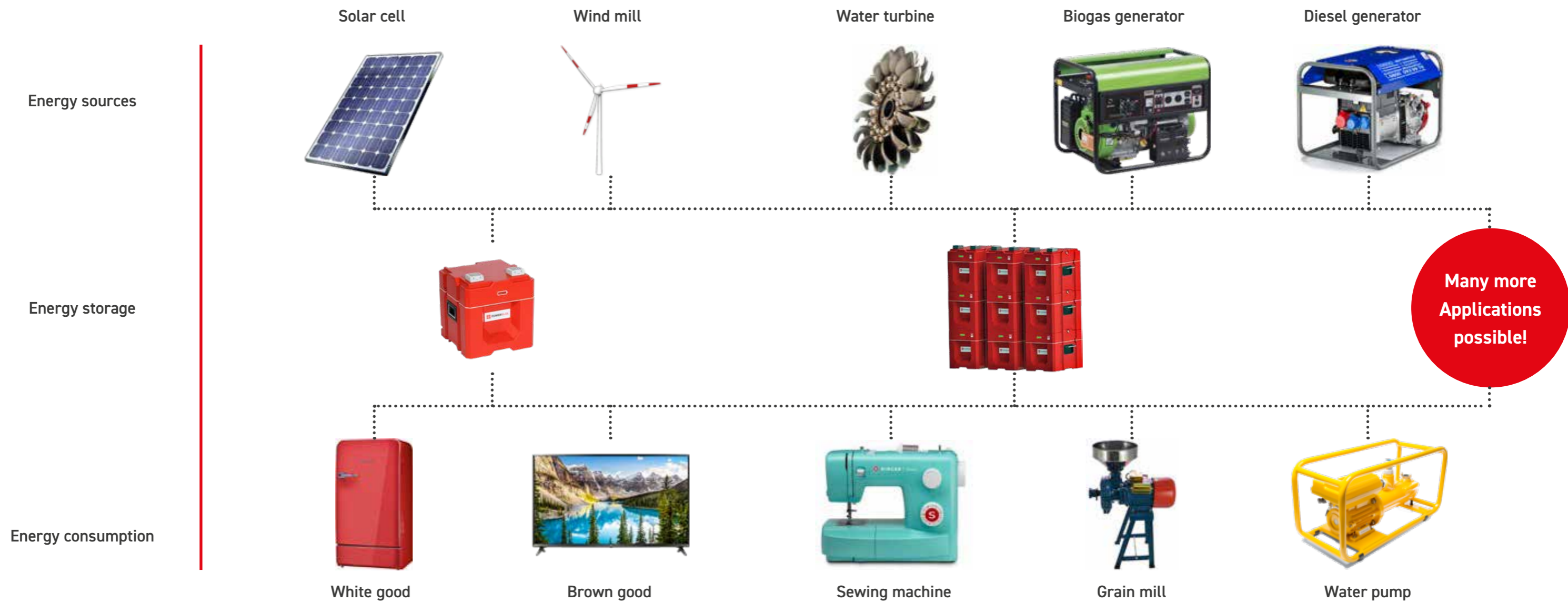

Full remote control via cloud monitoring

DIGITIZED BUSINESS MODELS



..... Measuring Socio-Economic Impact

By measuring the consumption data of a household over a period of several months, conclusions can be drawn about socio-economic development. By using artificial intelligence, we can better and better determine the effects of an investment in energy infrastructure over time and how this improves the welfare of a region.

..... Fast Scale-up

Save yourself long and costly planning and evaluation phases in the field. Thanks to satellite-supported planning and analysis, most planning steps, including automated optimization of the grid, can be done from a desk. The roof-based analysis of consumers provides quick information about the right electrification solution and the structure of the optimal energy supply system.

..... Physical Data

Each Power-Blox installed can be remotely monitored via an IoT Gateway. In this way, maintenance requirements can be identified at an early stage and an optimum supply level can always be maintained.

Product Features

BENEFITS AT A GLANCE



Scalability and modularity

Power-Blox grows with your needs! Upfront costs and capacity over-investments were yesterday. Start with just a few Power-Blox and add more, when needed. Investors love it!



Fast and reliable realtime data

Power-Blox are ready for use in no time and deliver real time data for decision making. Predictions may be good, but we prefer the actual load profile and consumption.



Pay as you go & prosumer

We believe decisions based on real data are superior to predictions based on surveys. That's why we usually are on the fast lane for tariff and business model approval.

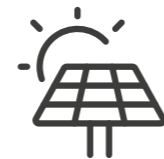

Clean energy immediately

Deployed in a matter of minutes with minimal ecological footprint.



Easy to use - Plug & Power

Place the solar module outside. Switch on the Power-Blox to get energy delivered to the integrated socket. Done!



Engineering and Maintenance

Our systems do not need any special skills to be configured, installed and maintained. Even bigger systems in the Kilowatt range can easily be built by simply connecting multiple cubes.



Intelligent & failure safe

The technology is self-configuring and self-learning. In case of any grid failure, the units automatically disconnect and run as autonomous off-grid power supplies.



Universal energy interface

Allows to easily combine various energy sources and battery technologies. While there are many solutions for energy storage, they cannot be combined as every solution with an integrated master device tries to control the grid and gets in conflict with other masters.



TECHNICAL DATA

Inverter	PBX-200 Pb	PBX-200 Li	PBX-200 Li/LE
Input PV / Mppt (DC)			
Absolute maximum voltage (VMAX PV)	45 V		
MPPT voltage range	30 V ... 45 V		
Maximum input DC power ¹	200 W		
Recommended PV input power ²	250 W ... 500 W		
Maximum DC input current	8 A		
Maximum short current (ISC PV) ²	8 A		
Solar connection type	Neutrik powerCON TRUE1 inlet / terminals 0.2-6 mm ²		
Reverse polarity protection	Yes		
Input Grid / Generator (AC)			
Input voltage range	220-240 V	-	
Maximum input current	10 A	-	
Grid frequency range	47 Hz ... 64 Hz	-	
Grid connection	C14 socket / terminals 0.2-6 mm ²	-	
Fuse	Resettable circuit breakers 10 A	-	
Equipotential bonding	Screw M6 (only from the series 1707.x.xxx and higher installed)		
Input / Output Transfer (AC)			
Transfer voltage range	220 - 240 V		
Maximum transfer current	10 A		
Transfer frequency range	47 Hz ... 64 Hz		
Transfer cable	1.7 m cable with Neutrik powerCON Plug		
Transfer socket	Neutrik powerCON inlet / terminals 0.2-6 mm ²		
Fuse	Resettable circuit breakers 10 A		
Sockets output rating, mains operation (AC)			
Voltage range	220-240 V	-	
Maximum continuous power ³	2'125 VA	-	
Maximum continuous current ⁴	9.25 A	-	
Frequency	47 Hz ... 64 Hz	-	
Power factor range	0.1 ... 1	-	
Amount	2		
Sockets output ratings, standalone operation (AC)			
Voltage range	220-240 V		
Maximum continuous power per PBX-200 ⁵	200 VA		
Maximum continuous current per PBX-200 ⁶	0.87 A		

Frequency	47 Hz ... 64 Hz	
Power factor range	0.1 ... 1	
Amount	2	
Car socket (DC)		
Voltage	12 V	
Maximum current	3 A	
Amount	1	
Total power (USB socket and car socket)	36 W	
USB sockets (DC)		
Voltage	5.0 V	
Maximum current	2 A	
Amount	2	
Total power (USB socket and car socket)	36 W	
Mains charge controller (AC)		
Continuous output voltage	220-240 V	
Continuous output power	200 VA	
Maximum output power for 3 seconds	400 VA	
Output frequency range	47 Hz ... 64 Hz	
Harmonic distortion	< 4%	
Power factor range	0.1 ... 1	
Mains charge controller (AC)		
Charging characteristic	IUoU ⁷	Li BMS ⁷
Input voltage range	220-240 V	
Maximum input power	175 VA	
Maximum input current	0.75 A	
Input frequency range	47 Hz ... 64 Hz	
Battery (DC)		
Integrated battery	2 x Hoppecke sun power VR M, 12 V 58Ah	2 x GreenLiFE 12 V, 50 AH or 1 x Ronda 24V, 50AH
Battery technology	Lead / AGM ⁸	Lithium / LiFePO ₄ ⁹
Battery capacity	1'392 Wh	1'200 Wh
Usable capacity	80%	90%
Internal battery voltage	24 V	
Expected lifetime	3 ... 10 years	>10 years

Swarm connector

Connecting multiple PBX-200	With integrated cable
Maximum stacking tower height	3 units
Maximum stacking / transfer capacity	10 units / 2 kW

Certifications

Electromagnetic compatibility (EMC)	IEC/EN55022, IEC/EN61000
Safety standards	EC/EN62109-1, IEC62109-2

Environmental conditions

Ingress Protection Marking	IP20	
Relative humidity	95% non condensing	
Operating temperature ¹⁰	-10 °C ... 45 °C ¹¹	-0 °C ... 50 °C ¹²
Ventilation	Passive, no active cooling	
Maximum operating altitude	2'000 m.a.s.l.	
Warranty	2 years	

General Data

Weight	42 kg	21 kg	20 kg
Dimensions (W / H / D)	400 mm / 443 mm / 400 mm		

¹ Maximum power the MPPT can handle.

² If the solar module can generate a higher current than 8.0 A, an additional string fuse must be used.

³ For each additional PBX-200 connected, the maximum continuous power decreases by 175 VA.

⁴ For each additional PBX-200 connected, the maximum continuous current decreases by 0.75 A.

⁵ For each additional PBX-200 connected, the maximum continuous power increases by 200 VA.

⁶ For each additional PBX-200 connected, the maximum continuous current increases by 0.87 A.

⁷ IUoU = Multi-stage charging process for optimum charging of batteries. BMS = Battery Management System

⁸ AGM = Absorbent Glass Mat, Electrolyte is bound in a fleece of glass fibers

⁹ LiFePo4 = Lithium iron phosphate

¹⁰ All technical data refer to an ambient temperature of 25° C.

¹¹ The batteries age much faster if the operating temperature remains above 30°C.

¹² The batteries age much faster if the operating temperature remains above 45°C.

Technical Data

SCHEMATIC DIAGRAM

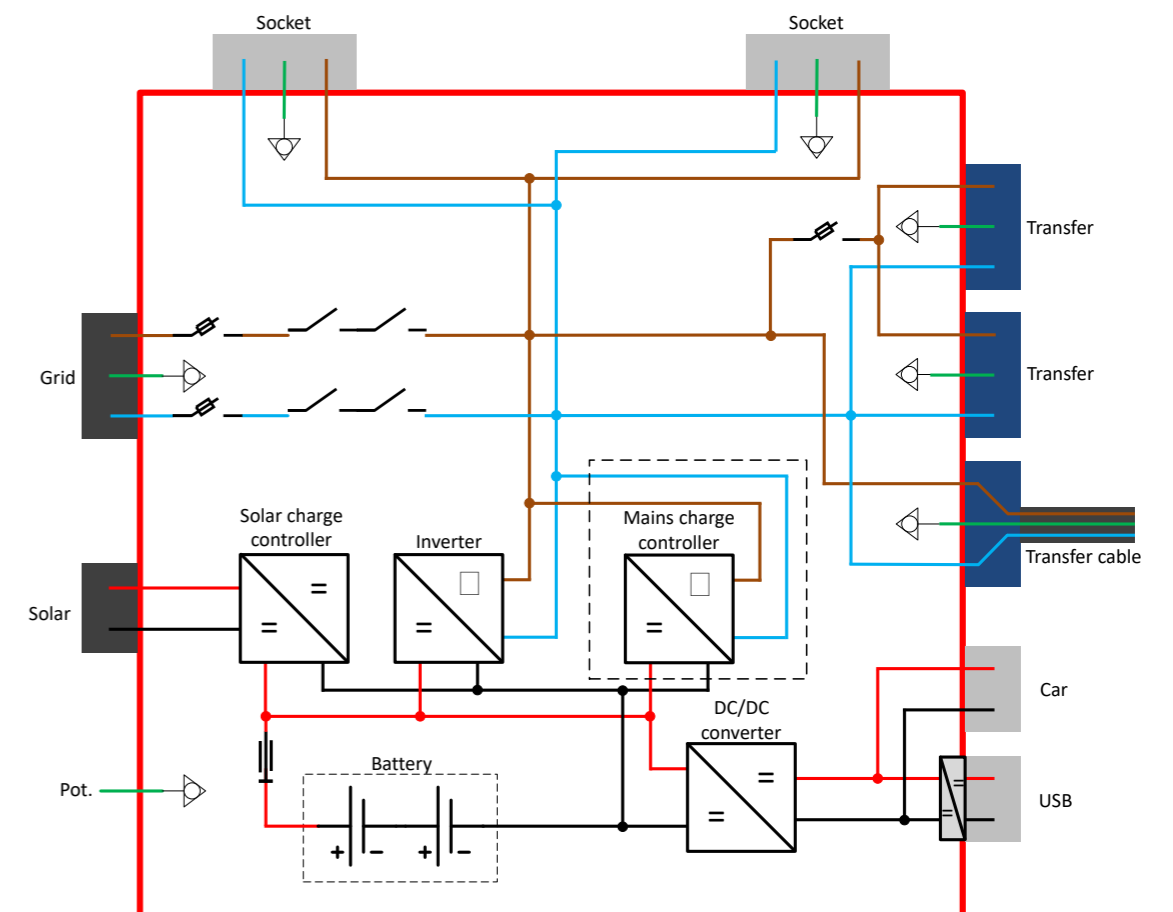

--- Mains charge controller
not available in LE-version.

Pot. Only from the series 1707.x.xxx
and higher installed.



■ Power-Blox Departments ● Power-Blox Projects

Power-Blox

GET IN TOUCH

Power-Blox AG

Dammstrasse 3
5070 Frick
Switzerland

Phone: +41 56 450 96 96

E-Mail: info@power-blox.com

Web: www.power-blox.com

*Power-Blox is a trademark of Power-Blox AG, registered in Switzerland and other countries. We reserve the right to modify product specifications without prior notice. © Power-Blox 2020. info@power-blox.com
Photo credits: Power-Blox AG, SDC/DEZA, unsplash.com, freepik.com (Travel vector created by Layera-ce), shutterstock.com.*